

O C

2019

The operating catalogue is the main work tool that Platek makes available to its referents – trades, architects, specialists, light and landscape designers, end customers – offering a complete overview of its production. Over 2000 product references are subdivided into three macro sections: technical, decorative and interior technical architecture. It is proposed, today, in its updated and renewed version. While not changing in its nature and purpose, it has been optimized in the graphics and organization of content for the purpose of offering a practical and more immediate use guide to its users. The main focus of Platek is to establish an increasingly clear and precise relationship with its partners.

Each product or accessory is accompanied by all the required information for the user: materials, dimensions, technical specifications and performance. Inside it you can also find information on the stock availability of standard products, information on discontinued products, as well as versions available (on request): taking into account that the data in this catalogue are valid at the date of printing (April 2019) and that the website www.platek.eu is the tool updated in real time as a complement of hard copies.

Outdoor lighting has always been Platek's core business. Platek's products stand out for their high technological level, innovation, design and certified quality. Since the early stages of design, the durability of the product is another of the key objectives, so the development process is taken care of down to the last detail in order to guarantee it. The control of light and its effect is at the centre of the design of each product, whether it is an architectural lighting system or a decorative luminaire: in Platek the definition of the lighting project can't ignore the research on the light sources and on their lighting effects. Thanks to a very accurate study of the optical systems, Platek manages to define, since the origin of the product, the type of lighting effect that it will deliver. For every project, whether public or private, Platek acts like a real partner that can provide, upon request, a lighting calculation. In addition to the information contained in this catalogue and the already varied range of products presented in it, the technical department is available to develop specific solutions for each lighting project.

O

C

2019

Outdoor
Table lamp

P 12
MESH battery
charged



P 12
MESH table



P 12
MESH battery
limited edition



P 12
MESH table
limited edition



P 16
ETEREA



P 16
ETEREA battery
charged



Floodlight

P 15
FROG



Downlight

P 13
MESH



P 13
MESH XL



P 15
FROG



P 18
FLAMINGO 2.0



P 19
ESAGONO



Wall effect

P 13
MESH



P 17
ETEREA



P 15
FROG



P 20
CHIODO



P 18
FLAMINGO 2.0



P 19
ESAGONO



Bollard and floor

P 14
MESH bollard /
floor



P 14
MESH XL floor



P 16
ETEREA



P 15
FROG bollard /
floor



P 20
CHIODO



P 19
FLAMINGO 2.0
bollard / floor



P 17
PASSO



P 19
ESAGONO



P 21
STICK bollard



P 21
BLOCK bollard



Walk over

P 24
PICO
→ FULL INOX



P 24
NANO collection
→ FULL INOX



P 26
MINI CORNICHE
collection



P 28
TETRA INCASSO
collection



P 29
TETRA
CONTINUO



Drive over

P 30
MICRO collection
→ FULL INOX



P 31
MINI collection
→ FULL INOX



P 34
MEDIO collection
→ FULL INOX



P 32
MINI collection



P 34
MEDIO collection



P 37
ATLANTIQUE



Roll over

P 17
PASSO



P 40
NANO
→ FULL INOX



P 40
MICRO
→ FULL INOX



P 41
MINI



P 41
MEDIO



Wall recessed

P 30
MICRO
asymmetrical
collection



P 42
SPY collection



P 44
TEAM collection



P 45
FRAME



P 45
MASK



P 46
PROMENADE
collection



Floodlight

P 47
TARSIVS
collection



P 48
SUN collection



P 50
TARGET
collection



P 52
NANO
→ FULL INOX



P 52
NANO collection



P 54
MINI ONE
collection



Underwater

P 59
MINI CORNICHE
collection
→ FULL INOX



P 60
NETTUNO
collection



P 61
ATLANTIQUE
collection



P 62
STEEL
collection
→ FULL INOX



P 37
GRANDE



P 38
TETRA INCASSO
900 collection



P 46
MILANO 2



P 47
FLIC



P 54
ONE 2.0 collection



P 55
MINI SPECIAL
collection



P 56
SPRING collection



P 58
MINI collection



P 58
STEEL collection
→ FULL INOX



Ceiling recessed

P 63
MINI CORNICHE
collection



P 66
NANO collection



P 66
MICRO collection



P 67
MINI collection



P 67
OBLÒ



Downlight

P 68
PIX collection



P 69
SPOT



P 70
MINI ONE
collection



P 70
ONE 2.0 collection



P 71
MINI SPECIAL
collection



P 71
SPECIAL
collection



Wall effect

P 20
CHIODO



P 68
PIX collection



P 73
BLEND



P 74
MINI ONE
collection



P 74
ONE 2.0
collection



P 75
MINI SPECIAL
collection



Wall washer

P 80
MINI CORNICHE
collection



P 82
TETRA
CORNICHE
collection



P 84
TETRA LINEARE



Lighting posts

P 85
BLEND collection



P 85
TEAM collection



P 86
ALIEN



P 86
MOON collection



P 87
SLIM



P 87
MINI ONE
collection



Service post

P 129
SERVICE POST



P 72
CIRCUS



P 72
DOWNLIGHT



P 75
SPECIAL
collection



P 76
MOON collection



P 76
TETRA collection



P 78
MONACO
collection



P 79
BALI



P 88
MENHIR
collection



P 89
TRIS



P 89
TUBE



P 90
T4



P 90
TETRA PARCO



Residential lighting

P 89
TRISP 89
TUBEP 90
T4P 90
TETRA PARCOP 91
TARSIVS
pole mountedP 91
MONACO
pole mounted

Indoor lighting

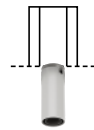
P 96
E2 plusP 96
E4 plusP 97
E2 plasterP 97
E2 reinforced
concreteP 97
E2 appoggioP 98
M'ATTACCO 1.0

Control systems

P 102
REGO 24P 102
REGO 48P 103
REGO 384P 105
Power suppliesP 109
ConnectorsP 110
FiltersP 112
Recessed boxesP 120
FixingP 126
Rods / Poles
extensions

P 92
BALI
pole mounted



P 98
M'ATTACCO 2.0

P 99
M'ATTACCO 3.0



P 130
Various

Decorative outdoor lig

12-21

hting

MESH table design by Marco Acerbis

Battery charged Cable version



IP65, IK 07

available colours
.02 white; .09 bronze

Table: cable 3 m
(C/W IP44 SCHUKO plug)
Battery version: USB cable 1,2 m length

platek.eu/MESH

Battery life: 6 hours

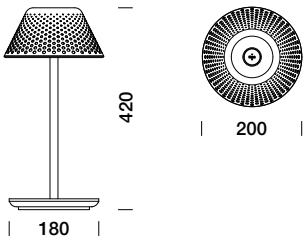

MESH table battery charged

LED white - \diamond
LED Data= 3000K (450 lm) - 4000K (468 lm)

32 55 116	●	4,5W	3000K (115 lm)	87°
32 55 166	○	4,5W	4000K (120 lm)	87°

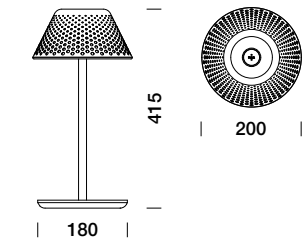

MESH table

LED white - 220-240V 50/60Hz \oplus
LED Data= 3000K (1050 lm) - 4000K (1090 lm)

32 50 116	●	12W	3000K (295 lm)	87°
32 50 166	○	12W	4000K (305 lm)	87°

Battery charged

Cable version

MESH limited edition design by Marco Acerbis with Baolab

Red version Blue version Gold version Green version



IP65, IK 07

Table: cable 2 m
(C/W IP44 SCHUKO plug)
Battery version: USB cable 1,2 m length

platek.eu/MESH

Battery life: 6 hours

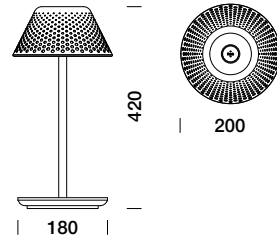

MESH limited edition battery charged

LED white \diamond
LED Data= 3000K (450 lm)

32 56 116.123	●	4,5W	3000K (115 lm)	87°	Red
32 56 116.122	●	4,5W	3000K (115 lm)	87°	Blue
32 56 116.120	●	4,5W	3000K (115 lm)	87°	Gold
32 56 116.121	●	4,5W	3000K (115 lm)	87°	Green

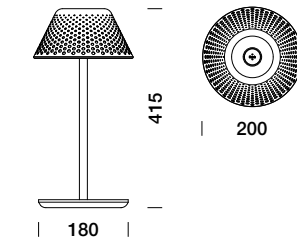

MESH limited edition table

LED white - 220-240V 50/60Hz \oplus
LED Data= 3000K (1050 lm)

32 51 116.123	●	12W	3000K (295 lm)	87°	Red
32 51 116.122	●	12W	3000K (295 lm)	87°	Blue
32 51 116.120	●	12W	3000K (295 lm)	87°	Gold
32 51 116.121	●	12W	3000K (295 lm)	87°	Green

Battery charged

Cable version

ACCESSORIES

89 56 014	●	Switching power supply MESH battery
89 10 502	●	Service post H. 500 mm (colour .08)
90 05 165	●	Floor fixing plate IP68 connector code
89 17 014	●	included (MESH floor)

ACCESSORIES

89 56 014	●	Switching power supply MESH battery
89 10 502	●	Service post H. 500 mm (colour .08)

MESH applique / downlight design by Marco Acerbis



IP65, IK 06 applique
IP65, IK 07 downlight

available colours
.02 white; .09 bronze

IP68 connector included

platek.eu/MESH

Applique

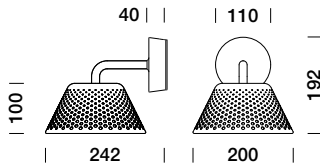

Downlight

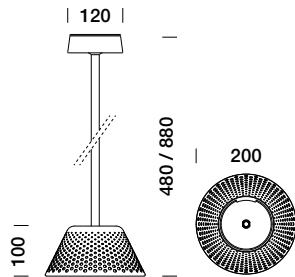

MESH applique

LED white - 220-240V 50/60Hz \oplus
LED Data= 3000K (1050 lm) - 4000K (1090 lm)

32 10 116	●	12W	3000K (310 lm)	87°
32 10 166	○	12W	4000K (320 lm)	87°

MESH downlight H. 480 / 880 mm

LED white - 220-240V 50/60Hz \oplus
LED Data= 3000K (1050 lm) - 4000K (1090 lm)

32 70 116	●	12W	3000K (310 lm)	87°	H. 480 mm
32 70 166	○	12W	4000K (320 lm)	87°	H. 480 mm
32 70 216	●	12W	3000K (310 lm)	87°	H. 880 mm
32 70 266	○	12W	4000K (320 lm)	87°	H. 880 mm

MESH XL downlight design by Marco Acerbis



IP65, IK 07

available colours
.02 white; .09 bronze

IP68 connector included

platek.eu/MESH

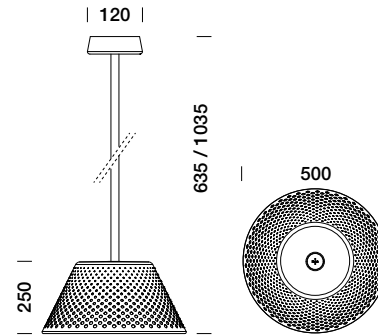

MESH XL downlight H. 635 / 1035 mm

LED white - 220-240V 50/60Hz \oplus
TRIAC dimmable
LED Data= 3000K (2625 lm) - 4000K (2730 lm)

32 70 616	●	27W	3000K (1625 lm)	75°	H. 635 mm
32 70 666	○	27W	4000K (1690 lm)	75°	H. 635 mm
32 70 816	●	27W	3000K (1625 lm)	75°	H. 1035 mm
32 70 866	○	27W	4000K (1690 lm)	75°	H. 1035 mm

MESH bollard / floor

design by Marco Acerbis



IP65, IK 07

available colours
.02 white; .09 bronze

Bollard: IP68 connector included
Floor: 3 m cable length
(C/W IP44 SCHUKO plug)

platek.eu/MESH

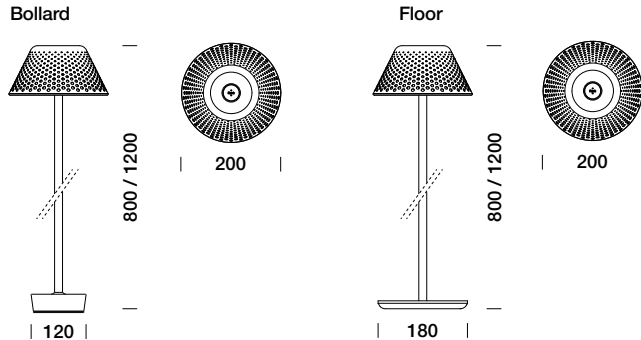

MESH bollard H. 800 / 1200 mm
LED white - 220-240V 50/60Hz ⊕
LED Data= 3000K (1050 lm) - 4000K (1090 lm)

32 40 216	●	12W	3000K (295 lm)	87°	H. 800 mm
32 40 266	○	12W	4000K (305 lm)	87°	H. 800 mm
32 40 316	●	12W	3000K (295 lm)	87°	H. 1200 mm
32 40 366	○	12W	4000K (305 lm)	87°	H. 1200 mm

MESH floor H. 800 / 1200 mm
LED white - 220-240V 50/60Hz ⊕
LED Data= 3000K (1050 lm) - 4000K (1090 lm)

32 50 216	●	12W	3000K (295 lm)	87°	H. 800 mm
32 50 266	○	12W	4000K (305 lm)	87°	H. 800 mm
32 50 316	●	12W	3000K (295 lm)	87°	H. 1200 mm
32 50 366	○	12W	4000K (305 lm)	87°	H. 1200 mm

ACCESSORIES

89 50 120	●	Tie-rod (MESH bollard)
90 05 160	●	Spike (MESH bollard)
90 05 165	●	Floor fixing plate c/w IP68 connector code 89 17 014 (MESH floor)
89 10 502	●	Service post H. 500 mm (colour .08)

MESH XL floor

design by Marco Acerbis



IP65, IK 07

available colours
.02 white; .09 bronze

3 m cable length
(C/W IP44 SCHUKO plug)

platek.eu/MESH

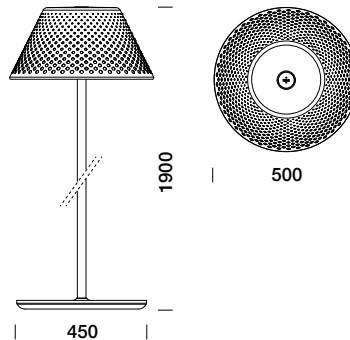

MESH XL floor H. 1900 mm
LED white - 220-240V 50/60Hz ⊕
TRIAC dimmable
LED Data= 3000K (2625 lm) - 4000K (2730 lm)

32 50 816	●	27W	3000K (1515 lm)	75°
32 50 866	○	27W	4000K (1580 lm)	75°

ACCESSORIES

90 05 130	●	Tie-rod (MESH XL)
-----------	---	-------------------

FROG

design by Sara Moroni

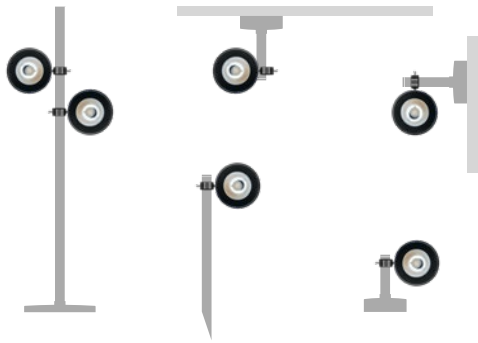

IP66, IK 08

available colours
.01 black; .02 white; .09 bronze

3 m cable length
Product to be composed
Supports to be ordered separately

platek.eu/FROG

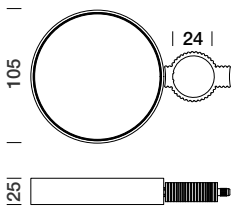

LED white - 220-240V 50/60Hz ⊕
TRIAC dimmable
LED Data= 3000K (900 lm) - 4000K (936 lm)

88 00 011	●	11W	3000K (650 lm)	26°
88 00 061	○	11W	4000K (675 lm)	26°
88 00 013	●	11W	3000K (595 lm)	45°
88 00 063	○	11W	4000K (620 lm)	45°
88 00 018	●	11W	3000K (570 lm)	102°
88 00 068	○	11W	4000K (590 lm)	102°

ACCESSORIES

89 51 105	●	Base with pole H. 160 mm (in colour .01 .02 .09)
89 51 110	●	Base with pole H. 500 mm (in colour .01 .02 .09)
89 51 115	●	Base with pole H. 1100 mm (in colour .01 .02 .09)
90 05 175	●	Spike H. 160 mm height above ground (in colour .01 .02 .09)
90 05 180	●	Spike H. 500 mm height above ground (in colour .01 .02 .09)
90 05 185	●	Spike H. 1100 mm height above ground (in colour .01 .02 .09)
90 05 186	●	Spike H. 2200 mm height above ground (in colour .01 .02 .09)
89 51 230	●	Floor H. 2300 mm (in colour .01 .02 .09)
89 18 057	●	Extensive filter (in colour .01 .02)
89 18 055	●	Elliptical filter (in colour .01 .02)
89 05 065	●	Honeycomb filter (in colour .01 .02)
89 05 060	●	Shield visor
89 18 058	●	Visor with extensive filter
89 18 059	●	Visor with elliptical filter
89 05 066	●	Honeycomb filter (to be used in addition to filters/visors)
90 05 170	●	Spike for pole
89 17 014	●	IP68 connector for 3x1,5 mm ² cable
89 10 502	●	Service post H. 500 mm (colour .08)

● Product available in stock

○ Product available on request

FROG floodlight

design by Sara Moroni



IP66, IK 08

available colours
.01 black; .02 white; .09 bronze

3 m cable length

platek.eu/FROG

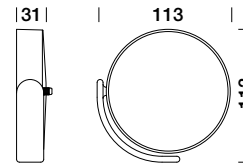

FROG floodlight
LED white - 220-240V 50/60Hz ⊕
TRIAC dimmable
LED Data= 3000K (900 lm) - 4000K (936 lm)

88 00 111	●	11W	3000K (650 lm)	26°
88 00 161	○	11W	4000K (675 lm)	26°
88 00 113	●	11W	3000K (595 lm)	45°
88 00 163	○	11W	4000K (620 lm)	45°
88 00 118	●	11W	3000K (570 lm)	102°
88 00 168	○	11W	4000K (590 lm)	102°

ACCESSORIES

89 18 057	●	Extensive filter (in colour .01 .02)
89 18 055	●	Elliptical filter (in colour .01 .02)
89 05 065	●	Honeycomb filter (in colour .01 .02)
89 05 060	●	Shield visor
89 18 058	●	Visor with extensive filter
89 18 059	●	Visor with elliptical filter
89 05 066	●	Honeycomb filter (to be used in addition to filters/visors)
89 17 014	●	IP68 connector for 3x1,5 mm ² cable
90 05 610	●	Spike
90 05 105	●	Anchor belt

● Product available on request until the end of stocks

ETEREA battery



IP65, IK 07

available colours
.02 white; .07 corten

Battery life: 6 hours

platek.eu/ETEREA

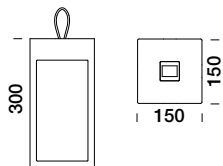

ETEREA battery
LED white - \diamond
LED Data= 3000K (450 lm)

94 14 219 ● 4,5W 3000K (150 lm) 120°

ACCESSORIES

- 89 56 014 ● Switching power supply ETEREA battery
- 94 99 007 ● PMMA support feet with anti-scratch rubber

ETEREA 2.0 design by Danesi & Buzzoni



IP65, IK 08

available colours
.02 white; .07 corten; .08 anthracite

5 m cable length

platek.eu/ETEREA

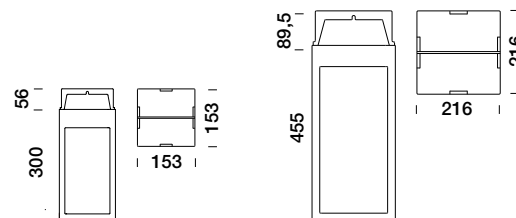

ETEREA 2.0 Medium
LED white - 220-240V 50/60Hz \oplus
LED Data= 3000K (750 lm) - 4000K (780 lm)

94 14 319 ● 9W 3000K (325 lm) 120°
94 14 369 ○ 9W 4000K (340 lm) 120°

ETEREA 2.0 Large
LED white - 220-240V 50/60Hz \oplus
LED Data= 3000K (1550 lm) - 4000K (1612 lm)

94 14 819 ● 20W 3000K (510 lm) 140°
94 14 869 ○ 20W 4000K (530 lm) 140°

ACCESSORIES

- 89 17 004 ● IP68 IN/OUT connector for 3x4 mm² cable
- 89 17 014 ● IP68 connector for 3x1,5 mm² cable
- 89 10 502 ● Service post H. 500 mm (colour .08)

ETEREA 2.0 applique design by Danesi & Buzzoni



IP65, IK 08

available colours
.02 white; .07 corten; .08 anthracite

IP68 connector included

platek.eu/ETEREA

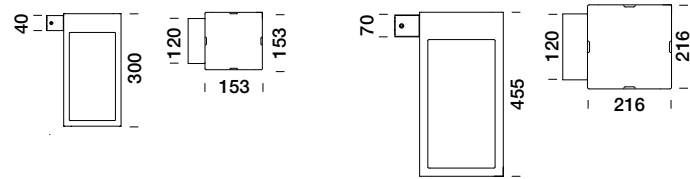

ETEREA 2.0 Medium applique

LED white - 220-240V 50/60Hz

LED Data= 3000K (750 lm) - 4000K (780 lm)

94 14 419	●	9W	3000K (325 lm)	120°
94 14 469	○	9W	4000K (340 lm)	120°

ETEREA 2.0 Large applique

LED white - 220-240V 50/60Hz

LED Data= 3000K (1550 lm) - 4000K (1612 lm)

94 14 919	●	20W	3000K (510 lm)	140°
94 14 969	○	20W	4000K (530 lm)	140°

PASSO design by Danesi & Buzzoni

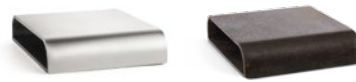

IP65, IK 06

3 m cable length

platek.eu/PASSO

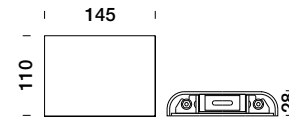

PASSO

COB LED white - 24V DC

(power supply to be ordered separately)

LED Data= 3000K (610 lm) - 4000K (634 lm)

94 04 411	●	7,5W	3000K (85 lm)	AISI 316 stainless steel
94 04 461	○	7,5W	4000K (90 lm)	AISI 316 stainless steel
94 04 711	●	7,5W	3000K (85 lm)	Corten steel
94 04 761	○	7,5W	4000K (90 lm)	Corten steel

ACCESSORIES

90 05 120	●	Spike
89 17 006	●	IP68 connector for 2x0,75 mm ² cable
89 17 012	●	IP68 connector for 4x1,5 mm ² cable
89 56 104	●	IP20 Power supply (24V DC - 30W)
89 56 307	●	IP20 Power supply (24V DC - 75W)
89 56 172	●	IP67 Power supply (24V DC - 30W)
89 56 127	●	IP67 Power supply (24V DC - 75W)
89 56 074	●	IP67 Power supply (24V DC - 150W)
ON/OFF		Further power supplies are available on page 105

FLAMINGO 2.0 applique design by Sara Moroni



FLAMINGO 2.0 downlight design by Sara Moroni

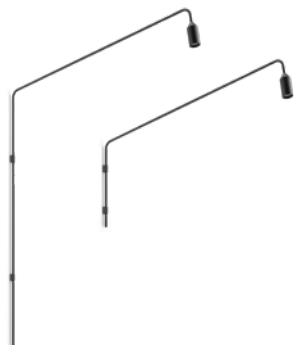

IP65, IK 06

available colours
.01 black; .09 bronze

platek.eu/FLAMINGO

IP65, IK 06

available colours
.01 black; .09 bronze

platek.eu/FLAMINGO

Applique 300

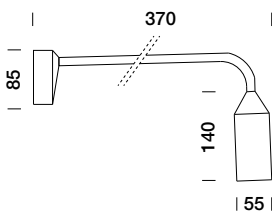

FLAMINGO 2.0 - 300 applique

LED white - 220-240V 50/60Hz

TRIAC dimmable

LED Data= 3000K (705 lm) - 4000K (733 lm)

30 10 116	●	9W	3000K (385 lm)	76°
30 10 166	○	9W	4000K (400 lm)	76°

Downlight 170

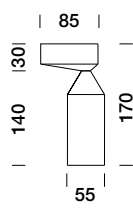

Downlight 800

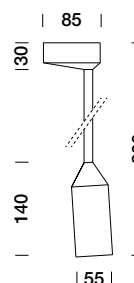

FLAMINGO 2.0 downlight - H. 170 / 800 mm

LED white - 220-240V 50/60Hz

TRIAC dimmable

LED Data= 3000K (705 lm) - 4000K (733 lm)

30 70 116	●	9W	3000K (385 lm)	76°	H. 170 mm
30 70 166	○	9W	4000K (400 lm)	76°	H. 170 mm
30 70 216	●	9W	3000K (385 lm)	76°	H. 800 mm
30 70 266	○	9W	4000K (400 lm)	76°	H. 800 mm

Applique 850

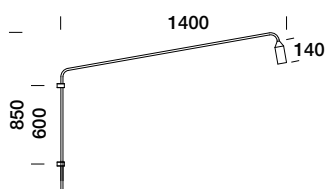

FLAMINGO 2.0 - H. 850 applique

LED white - 220-240V 50/60Hz

TRIAC dimmable

LED Data= 3000K (705 lm) - 4000K (733 lm)

30 10 216	●	9W	3000K (385 lm)	76°
30 10 266	○	9W	4000K (400 lm)	76°

Applique 2200

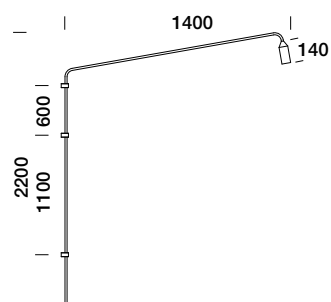

FLAMINGO 2.0 - H. 2200 applique

LED white - 220-240V 50/60Hz

TRIAC dimmable

LED Data= 3000K (705 lm) - 4000K (733 lm)

30 10 316	●	9W	3000K (385 lm)	76°
30 10 366	○	9W	4000K (400 lm)	76°

FLAMINGO 2.0 bollard / floor design by Sara Moroni



ESAGONO design by Maurizio Quargnale



IP65, IK 06

available colours
.01 black; .09 bronze

Bollard: IP68 connector included
Floor: 5 m cable length

platek.eu/FLAMINGO

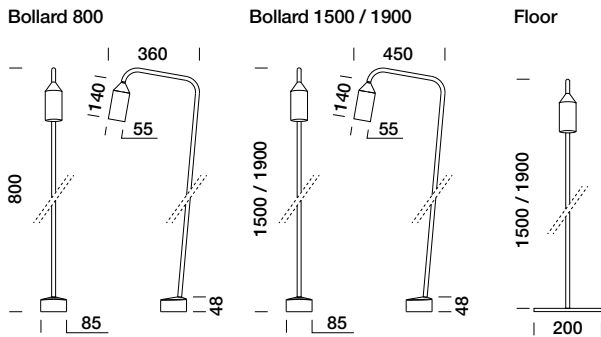

FLAMINGO bollard H. 800 / 1500 / 1900 mm
LED white - 220-240V 50/60Hz ⊕
TRIAC dimmable
LED Data= 3000K (705 lm) - 4000K (733 lm)

30 40 116	●	9W	3000K (385 lm)	76°	H. 800 mm
30 40 166	○	9W	4000K (400 lm)	76°	H. 800 mm
30 40 216	●	9W	3000K (385 lm)	76°	H. 1500 mm
30 40 266	○	9W	4000K (400 lm)	76°	H. 1500 mm
30 40 316	●	9W	3000K (385 lm)	76°	H. 1900 mm
30 40 366	○	9W	4000K (400 lm)	76°	H. 1900 mm

FLAMINGO floor H. 1500 / 1900 mm
LED white - 220-240V 50/60Hz ⊕
TRIAC dimmable
LED Data= 3000K (705 lm) - 4000K (733 lm)

30 50 216	●	9W	3000K (385 lm)	76°	H. 1500 mm
30 50 266	○	9W	4000K (400 lm)	76°	H. 1500 mm
30 50 316	●	9W	3000K (385 lm)	76°	H. 1900 mm
30 50 366	○	9W	4000K (400 lm)	76°	H. 1900 mm

ACCESSORIES

89 50 040	●	Tie-rod (FLAMINGO bollard)
89 50 041	●	Spike (FLAMINGO bollard)
89 10 502	●	Service post H. 500 mm (colour .08)

● Product available in stock

○ Product available on request

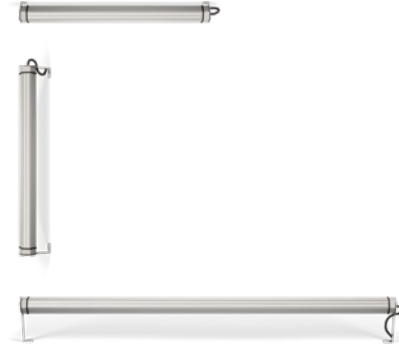

IP65, IK 05

available colours
.06 grey; .09 bronze

5 m cable length

platek.eu/ESAGONO



ESAGONO 600 mm
LED white - 220-240V 50/60Hz ⊕
LED Data= 3000K (788 lm) - 4000K (820 lm)

84 86 614	●	10,5W	3000K (340 lm)	75°
84 86 664	○	10,5W	4000K (355 lm)	75°

ESAGONO 1200 mm
LED white - 220-240V 50/60Hz ⊕
LED Data= 3000K (1680 lm) - 4000K (1747 lm)

84 86 616	●	25W	3000K (775 lm)	75°
84 86 666	○	25W	4000K (805 lm)	75°

ACCESSORIES

89 47 070	●	Adjustable ground fixing spikes for horizontal mounting
89 47 067	●	Stainless steel spike for vertical mounting
89 47 066	●	Hook fastener
89 47 071	●	Adjustable wall fixing 65 mm
89 47 068	●	Adjustable wall fixing 150 mm
89 47 069	●	Adjustable wall fixing 100 mm
89 17 004	●	IP68 IN/OUT connector for 3x4 mm ² cable
89 10 502	●	Service post H. 500 mm (colour .08)

● Product available on request until the end of stocks

CHIODO applique



IP65, IK 05

available colours
.01 black; .02 white

IP68 connector included

platek.eu/CHIODO

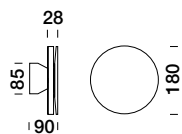

CHIODO applique
COB LED white - 220-240V 50/60Hz ⊕
LED Data= 3000K (710 lm) - 4000K (738 lm)

94 02 816	●	12W	3000K (345 lm)	121°
94 02 866	○	12W	4000K (360 lm)	121°

CHIODO bollard design by Danesi & Buzzoni



IP65, IK 05

available colours
.01 black

H. 600 mm: 4,4 m cable length
H. 1100 mm: 3,9 m cable length
H. 1700 mm: 3,3 m cable length

platek.eu/CHIODO

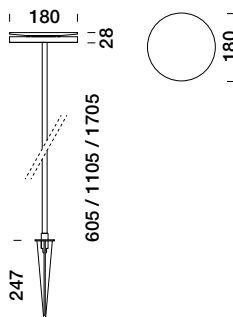

CHIODO H. 600 / 1100 / 1700 mm
COB LED white - 220-240V 50/60Hz ⊕
LED Data= 3000K (710 lm) - 4000K (738 lm)

94 02 116	●	12W	3000K (660 lm)	121°	H. 600 mm
94 02 166	○	12W	4000K (685 lm)	121°	H. 600 mm
94 02 216	●	12W	3000K (660 lm)	121°	H. 1100 mm
94 02 266	○	12W	4000K (685 lm)	121°	H. 1100 mm
94 02 316	●	12W	3000K (660 lm)	121°	H. 1700 mm
94 02 366	○	12W	4000K (685 lm)	121°	H. 1700 mm

ACCESSORIES

89 51 100	●	Ground fixing base plate (in colour .01)
89 51 102	●	Ground fixing base in AISI 316L stainless steel with recessed box and Paguro connector (89 17 004)
89 17 014	●	IP68 connector for 3x1,5 mm ² cable
89 17 004	●	IP68 IN/OUT connector for 3x4 mm ² cable
89 10 502	●	Service post H. 500 mm (colour .08)

STICK

design by Gaspare Inglese



IP65, IK 06

platek.eu/STICK

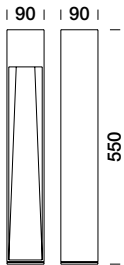

STICK
LED white - 220-240V 50/60Hz \square
LED Data= 3000K (750 lm) - 4000K (800 lm)

60 94 619	● 8,8W	3000K (240 lm)
60 94 669	○ 8,8W	4000K (250 lm)

BLOCK

design by Gaspare Inglese



IP65, IK 06

platek.eu/BLOCK

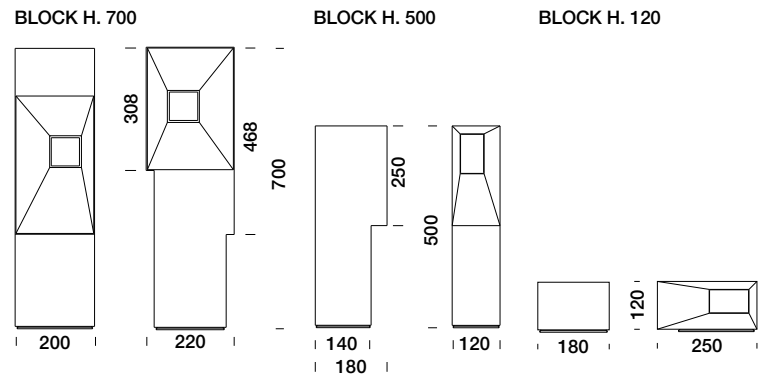

BLOCK H. 120 mm
LED white - 220-240V 50/60Hz \oplus
LED Data= 3000K (550 lm) - 4000K (590 lm)

60 93 619	○ 5,4W	3000K (100 lm)	Neutral
60 93 819	○ 5,4W	3000K (100 lm)	Anthracite
60 93 919	○ 5,4W	3000K (100 lm)	Terra
60 93 669	○ 5,4W	4000K (105 lm)	Neutral
60 93 869	○ 5,4W	4000K (105 lm)	Anthracite
60 93 969	○ 5,4W	4000K (105 lm)	Terra

BLOCK H. 500 mm
LED white - 220-240V 50/60Hz \oplus
LED Data= 3000K (1000 lm) - 4000K (1080 lm)

60 91 619	○ 9,8W	3000K (200 lm)	Neutral
60 91 819	○ 9,8W	3000K (200 lm)	Anthracite
60 91 919	○ 9,8W	3000K (200 lm)	Terra
60 91 669	○ 9,8W	4000K (205 lm)	Neutral
60 91 869	○ 9,8W	4000K (205 lm)	Anthracite
60 91 969	○ 9,8W	4000K (205 lm)	Terra

BLOCK H. 700 mm
LED white - 220-240V 50/60Hz \oplus
LED Data= 3000K (2000 lm) - 4000K (2160 lm)

60 90 619	○ 18W	3000K (250 lm)	Neutral
60 90 819	○ 18W	3000K (250 lm)	Anthracite
60 90 919	○ 18W	3000K (250 lm)	Terra
60 90 669	○ 18W	4000K (260 lm)	Neutral
60 90 869	○ 18W	4000K (260 lm)	Anthracite
60 90 969	○ 18W	4000K (260 lm)	Terra

Architektur outdoor lig

24—92

al
hting

PICO full inox

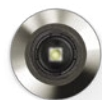

IP68 Full Dry (2m), IK 07
Walk over 500 Kg

5 m cable length

platek.eu/PICO

WALK OVER

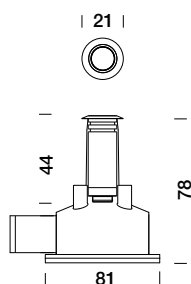

DOWNLIGHT

Fixing hole Ø 17 mm

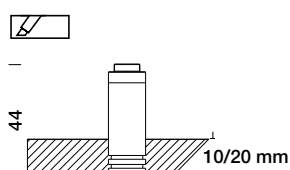

1 LED white - 12V DC -

(power supply and recessed box to be ordered separately)

LED Data= 3000K (125 lm) - 4000K (130 lm)

84 95 011	●	1,4W	3000K (85 lm)	20°
84 95 015	●	1,4W	3000K (45 lm)	80°
84 95 061	○	1,4W	4000K (90 lm)	20°
84 95 065	○	1,4W	4000K (45 lm)	80°

ACCESSORIES

89 45 040	●	Recessed box H. 78 mm - Ø 62 mm
89 17 006	●	IP68 connector for 2x0,75 mm ² cable
89 17 012	●	IP68 connector for 4x1,5 mm ² cable
89 56 109	●	IP20 Power supply (12V DC - 18W) max. 15 products
89 56 091	●	IP67 Power supply (12V DC - 14W) max. 10 products
89 56 103	●	IP67 Power supply (12V DC - 60W) max. 45 products
ON/OFF		Further power supplies are available on page 105

NANO full inox round

Diffuse



IP68 Full Dry (2m), IK 07
Walk over 500 Kg

0,5 m cable length

platek.eu/NANOINOX

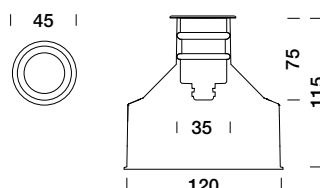

1 LED white - 700mA -

(power supply and recessed box to be ordered separately)

LED Data= 3000K (250 lm) - 4000K (260 lm)

84 00 011	●	2W	3000K (175 lm)	14°
84 00 013	●	2W	3000K (160 lm)	21°
84 00 015	●	2W	3000K (130 lm)	Diffuse Sandblasted
84 00 017	●	2W	3000K (160 lm)	Elliptical
84 00 018	●	2W	3000K (150 lm)	38°
84 00 061	○	2W	4000K (180 lm)	14°
84 00 063	○	2W	4000K (170 lm)	21°
84 00 065	○	2W	4000K (135 lm)	Diffuse Sandblasted
84 00 067	○	2W	4000K (165 lm)	Elliptical
84 00 068	○	2W	4000K (155 lm)	38°

ACCESSORIES

89 45 033	●	Recessed box H. 75 mm
89 45 034	●	Recessed box H. 200 mm
89 45 038	●	Recessed box H. 115 mm - base Ø 120 mm
89 45 039	●	Recessed box IP67 H. 160 mm base Ø 120 mm
89 17 006	●	IP68 connector for 2x0,75 mm ² cable
89 17 013	●	IP68 Micro Paguro connector for 2x1,5 mm ² cable
89 56 090	●	IP67 Power supply (700mA - 14W)
89 56 117	●	IP67 Power supply (700mA - 30W)
ON/OFF		Further power supplies are available on page 105

NANO full inox square

Diffuse



IP68 Full Dry (2m), IK 07
Walk over 500 Kg

0,5 m cable length

platek.eu/NANOINOX

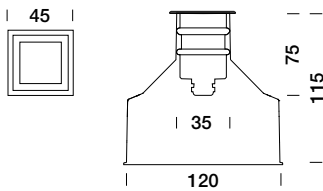

1 LED white - 700mA -

(power supply and recessed box to be ordered separately)

LED Data= 3000K (250 lm) - 4000K (260 lm)

84 70 011	●	2W	3000K (175 lm)	14°
84 70 013	●	2W	3000K (160 lm)	21°
84 70 015	●	2W	3000K (130 lm)	Diffuse Sandblasted
84 70 017	○	2W	3000K (160 lm)	Elliptical
84 70 018	○	2W	3000K (150 lm)	38°
84 70 061	○	2W	4000K (180 lm)	14°
84 70 063	○	2W	4000K (170 lm)	21°
84 70 065	○	2W	4000K (135 lm)	Diffuse Sandblasted
84 70 067	○	2W	4000K (165 lm)	Elliptical
84 70 068	○	2W	4000K (155 lm)	38°

ACCESSORIES

89 45 033	●	Recessed box H. 75 mm
89 45 034	●	Recessed box H. 200 mm
89 45 038	●	Recessed box H. 115 mm - base Ø 120 mm
89 45 039	●	Recessed box IP67 H. 160 mm base Ø 120 mm
89 17 006	●	IP68 connector for 2x0,75 mm ² cable
89 17 013	●	IP68 Micro Paguro connector for 2x1,5 mm ² cable
89 56 090	●	IP67 Power supply (700mA - 14W)
89 56 117	●	IP67 Power supply (700mA - 30W)
ON/OFF		Further power supplies are available on page 105

MINI CORNICHE 100

walk over



Diffuse



Asymmetric



IP67, IK 05
Walk over 500 Kg

LED white: 2 m cable length
LED RGBW: 2 m cable length

platek.eu/MINI-CORNICHE

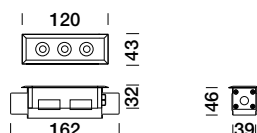

3 LED white - 24V DC - (power supply and recessed box to be ordered separately)
LED Data= 3000K (375 lm) - 4000K (390 lm)

84 98 111	○	3,5W	3000K (250 lm)	13°
84 98 113	○	3,5W	3000K (255 lm)	26°
84 98 118	○	3,5W	3000K (230 lm)	40°
84 98 117	○	3,5W	3000K (215 lm)	Elliptical
84 98 161	○	3,5W	4000K (260 lm)	13°
84 98 163	○	3,5W	4000K (265 lm)	26°
84 98 168	○	3,5W	4000K (245 lm)	40°
84 98 167	○	3,5W	4000K (225 lm)	Elliptical

LED white - 24V DC - (power supply and recessed box to be ordered separately)
LED Data= 3000K (120 lm) - 4000K (125 lm)

84 98 116	○	1,5W	3000K (90 lm)	Diffuse	Sandblasted
84 98 119	○	1,5W	3000K (60 lm)	Asymmetric	
84 98 166	○	1,5W	4000K (95 lm)	Diffuse	Sandblasted
84 98 169	○	1,5W	4000K (60 lm)	Asymmetric	

4 LED RGBW - 500mA - (power supply and recessed box to be ordered separately)

83 98 101	○	6W	RGBW	13°
83 98 103	○	6W	RGBW	26°
83 98 107	○	6W	RGBW	Elliptical
83 98 108	○	6W	RGBW	40°

ACCESSORIES

89 45 089	●	Recessed box H. 45 mm L. 162 mm
89 17 006	●	IP68 connector for 2x0,75 mm ² cable
89 17 012	●	IP68 connector for 4x1,5 mm ² cable
89 56 104	●	IP20 Power supply (24V DC - 30W)
89 56 307	●	IP20 Power supply (24V DC - 75W)
89 56 172	●	IP67 Power supply (24V DC - 30W)
89 56 127	●	IP67 Power supply (24V DC - 75W)
89 56 074	●	IP67 Power supply (24V DC - 150W)
ON/OFF		Further power supplies are available on page 105
RGBW		Control systems for dynamic light on page 102

● Product available in stock

○ Product available on request

MINI CORNICHE 300

walk over



Diffuse



Asymmetric



IP67, IK 05
Walk over 500 Kg

LED white: 2 m cable length
LED RGBW: 2 m cable length

platek.eu/MINI-CORNICHE

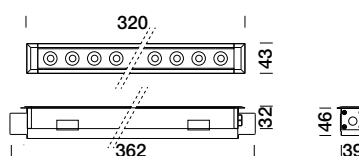

9 LED white - 24V DC - (power supply and recessed box to be ordered separately)
LED Data= 3000K (1125 lm) - 4000K (1170 lm)

84 98 311	○	9,5W	3000K (750 lm)	13°
84 98 313	○	9,5W	3000K (770 lm)	26°
84 98 318	○	9,5W	3000K (700 lm)	40°
84 98 317	○	9,5W	3000K (650 lm)	Elliptical
84 98 361	○	9,5W	4000K (780 lm)	13°
84 98 363	○	9,5W	4000K (800 lm)	26°
84 98 368	○	9,5W	4000K (730 lm)	40°
84 98 367	○	9,5W	4000K (675 lm)	Elliptical

LED white - 24V DC - (power supply and recessed box to be ordered separately)
LED Data= 3000K (560 lm) - 4000K (582 lm)

84 98 316	○	5,5W	3000K (415 lm)	Diffuse	Sandblasted
84 98 319	○	6W	3000K (170 lm)	Asymmetric	
84 98 366	○	5,5W	4000K (430 lm)	Diffuse	Sandblasted
84 98 369	○	6W	4000K (175 lm)	Asymmetric	

8 LED RGBW - 500mA - (power supply and recessed box to be ordered separately)

83 98 301	○	11,5W	RGBW	13°
83 98 303	○	11,5W	RGBW	26°
83 98 307	○	11,5W	RGBW	Elliptical
83 98 308	○	11,5W	RGBW	40°

ACCESSORIES

89 45 090	●	Recessed box H. 45 mm L. 362 mm
89 17 006	●	IP68 connector for 2x0,75 mm ² cable
89 17 012	●	IP68 connector for 4x1,5 mm ² cable
89 56 104	●	IP20 Power supply (24V DC - 30W)
89 56 307	●	IP20 Power supply (24V DC - 75W)
89 56 172	●	IP67 Power supply (24V DC - 30W)
89 56 127	●	IP67 Power supply (24V DC - 75W)
89 56 074	●	IP67 Power supply (24V DC - 150W)
ON/OFF		Further power supplies are available on page 105
RGBW		Control systems for dynamic light on page 102

● Product available on request until the end of stocks

MINI CORNICHE 600

walk over



Diffuse



Asymmetric



IP67, IK 05
Walk over 500 Kg

LED white: 2 m cable length
LED RGBW: 2 m cable length

platek.eu/MINI-CORNICHE

standard colour
.06 grey
other colours available on request with
no price increase
.01 black; .02 white; .07 corten;
.08 anthracite; .09 bronze

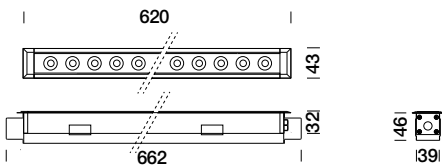

18 LED white - 24V DC - (power supply and recessed box to be ordered separately)
LED Data= 3000K (2250 lm) - 4000K (2340 lm)

84 98 511	○	18,5W	3000K (1500 lm)	13°
84 98 513	○	18,5W	3000K (1545 lm)	26°
84 98 518	○	18,5W	3000K (1400 lm)	40°
84 98 517	○	18,5W	3000K (1290 lm)	Elliptical
84 98 561	○	18,5W	4000K (1560 lm)	13°
84 98 563	○	18,5W	4000K (1605 lm)	26°
84 98 568	○	18,5W	4000K (1455 lm)	40°
84 98 567	○	18,5W	4000K (1345 lm)	Elliptical

LED white - 24V DC - (power supply and recessed box to be ordered separately)
LED Data= 3000K (1110 lm) - 4000K (1154 lm)

84 98 516	○	10,5W	3000K (825 lm)	Diffuse	Sandblasted
84 98 519	○	11W	3000K (335 lm)	Asymmetric	
84 98 566	○	10,5W	4000K (860 lm)	Diffuse	Sandblasted
84 98 569	○	11W	4000K (350 lm)	Asymmetric	

16 LED RGBW - 500mA - (power supply and recessed box to be ordered separately)

83 98 501	○	23W	RGBW	13°
83 98 503	○	23W	RGBW	26°
83 98 507	○	23W	RGBW	Elliptical
83 98 508	○	23W	RGBW	40°

ACCESSORIES

89 45 092	●	Recessed box H. 45 mm L. 662 mm
89 17 006	●	IP68 connector for 2x0,75 mm ² cable
89 17 012	●	IP68 connector for 4x1,5 mm ² cable
89 56 104	●	IP20 Power supply (24V DC - 30W)
89 56 307	●	IP20 Power supply (24V DC - 75W)
89 56 172	●	IP67 Power supply (24V DC - 30W)
89 56 127	●	IP67 Power supply (24V DC - 75W)
89 56 074	●	IP67 Power supply (24V DC - 150W)
ON/OFF		Further power supplies are available on page 105
RGBW		Control systems for dynamic light on page 102

● Product available in stock

○ Product available on request

MINI CORNICHE 900

walk over



Diffuse



Asymmetric



IP67, IK 05
Walk over 500 Kg

LED white: 2 m cable length
LED RGBW: 2 m cable length

platek.eu/MINI-CORNICHE

standard colour
.06 grey
other colours available on request with
no price increase
.01 black; .02 white; .07 corten;
.08 anthracite; .09 bronze

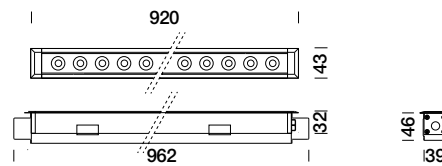

27 LED white - 24V DC - (power supply and recessed box to be ordered separately)
LED Data= 3000K (3375 lm) - 4000K (3510 lm)

84 98 711	○	29W	3000K (2255 lm)	13°
84 98 713	○	29W	3000K (2320 lm)	26°
84 98 718	○	29W	3000K (2100 lm)	40°
84 98 717	○	29W	3000K (1940 lm)	Elliptical
84 98 761	○	29W	4000K (2350 lm)	13°
84 98 763	○	29W	4000K (2415 lm)	26°
84 98 768	○	29W	4000K (2185 lm)	40°
84 98 767	○	29W	4000K (2020 lm)	Elliptical

LED white - 24V DC - (power supply and recessed box to be ordered separately)
LED Data= 3000K (1670 lm) - 4000K (1737 lm)

84 98 716	○	15,5W	3000K (1240 lm)	Diffuse	Sandblasted
84 98 719	○	17W	3000K (505 lm)	Asymmetric	
84 98 766	○	15,5W	4000K (1290 lm)	Diffuse	Sandblasted
84 98 769	○	17W	4000K (525 lm)	Asymmetric	

24 LED RGBW - 500mA - (power supply and recessed box to be ordered separately)

83 98 701	○	35W	RGBW	13°
83 98 703	○	35W	RGBW	26°
83 98 707	○	35W	RGBW	Elliptical
83 98 708	○	35W	RGBW	40°

ACCESSORIES

89 45 094	●	Recessed box H. 45 mm L. 962 mm
89 17 006	●	IP68 connector for 2x0,75 mm ² cable
89 17 012	●	IP68 connector for 4x1,5 mm ² cable
89 56 104	●	IP20 Power supply (24V DC - 30W)
89 56 307	●	IP20 Power supply (24V DC - 75W)
89 56 172	●	IP67 Power supply (24V DC - 30W)
89 56 127	●	IP67 Power supply (24V DC - 75W)
89 56 074	●	IP67 Power supply (24V DC - 150W)
ON/OFF		Further power supplies are available on page 105
RGBW		Control systems for dynamic light on page 102

● Product available on request until the end of stocks

MINI CORNICHE 1200

walk over

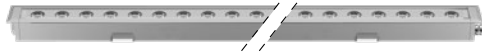

Diffuse



Asymmetric



IP67, IK 05
Walk over 500 Kg

standard colour
.06 grey
other colours available on request with
no price increase
.01 black; .02 white; .07 corten;
.08 anthracite; .09 bronze

LED white: 2 m cable length
LED RGBW: 2 m cable length

platek.eu/MINI-CORNICHE

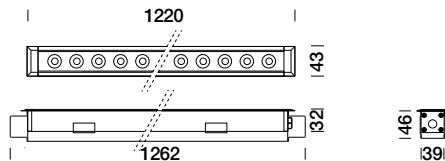

36 LED white - 24V DC - \diamond
(power supply and recessed box to be ordered separately)
LED Data= 3000K (4500 lm) - 4000K (5040 lm)

84 98 611	○	40W	3000K (3000 lm)	13°
84 98 613	○	40W	3000K (3090 lm)	26°
84 98 618	○	40W	3000K (2800 lm)	40°
84 98 617	○	40W	3000K (2590 lm)	Elliptical
84 98 661	○	40W	4000K (3125 lm)	13°
84 98 663	○	40W	4000K (3215 lm)	26°
84 98 668	○	40W	4000K (2900 lm)	40°
84 98 667	○	40W	4000K (2690 lm)	Elliptical

LED white - 24V DC - \diamond
(power supply and recessed box to be ordered separately)
LED Data= 3000K (2250 lm) - 4000K (2385 lm)

84 98 616	○	21W	3000K (1650 lm)	Diffuse	Sandblasted
84 98 619	○	22W	3000K (680 lm)	Asymmetric	
84 98 666	○	21W	4000K (1715 lm)	Diffuse	Sandblasted
84 98 669	○	22W	4000K (700 lm)	Asymmetric	

32 LED RGBW - 500mA - \diamond
(power supply and recessed box to be ordered separately)

83 98 601	○	46W	RGBW	13°
83 98 603	○	46W	RGBW	26°
83 98 607	○	46W	RGBW	Elliptical
83 98 608	○	46W	RGBW	40°

ACCESSORIES

89 45 093	●	Recessed box H. 45 mm L. 1262 mm
89 17 006	●	IP68 connector for 2x0,75 mm ² cable
89 17 012	●	IP68 connector for 4x1,5 mm ² cable
89 56 104	●	IP20 Power supply (24V DC - 30W)
89 56 307	●	IP20 Power supply (24V DC - 75W)
89 56 172	●	IP67 Power supply (24V DC - 30W)
89 56 127	●	IP67 Power supply (24V DC - 75W)
89 56 074	●	IP67 Power supply (24V DC - 150W)
ON/OFF		Further power supplies are available on page 105
RGBW		Control systems for dynamic light on page 102

TETRA INCASSO 360

0°÷15° tiltable



IP67, IK 10
Walk over 500 Kg

LED white: 1 m cable length
LED RGBW: 1 m cable length

platek.eu/TETRA-INCASSO

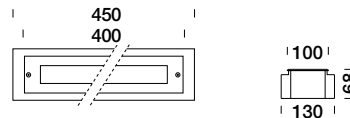

6 LED white - 220-240V 50/60Hz \oplus
LED Data= 3000K (750 lm) - 4000K (780 lm)

84 96 211	○	7,3W	3000K (565 lm)	12°
84 96 213	○	7,3W	3000K (535 lm)	26°
84 96 218	○	7,3W	3000K (470 lm)	40°
84 96 217	○	7,3W	3000K (465 lm)	Elliptical
84 96 261	○	7,3W	4000K (590 lm)	12°
84 96 263	○	7,3W	4000K (555 lm)	26°
84 96 268	○	7,3W	4000K (490 lm)	40°
84 96 267	○	7,3W	4000K (485 lm)	Elliptical

8 LED RGBW - 500mA - \diamond
(power supply to be ordered separately)

83 96 201	○	11,5W	RGBW	12°
83 96 203	○	11,5W	RGBW	26°
83 96 208	○	11,5W	RGBW	40°
83 96 207	○	11,5W	RGBW	Elliptical

ACCESSORIES

89 45 060	●	Recessed box AISI 304 stainless steel
89 17 014	●	IP68 connector for 3x1,5 mm ² cable
89 17 004	●	IP68 IN/OUT connector for 3x4 mm ² cable
RGBW		Control systems for dynamic light on page 102

TETRA INCASSO 360



IP67, IK 10
Walk over 500 Kg

LED white: 1 m cable length

platek.eu/TETRA-INCASSO

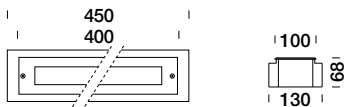

12 LED white - 220-240V 50/60Hz \oplus
LED Data= 3000K (1500 lm) - 4000K (1560 lm)

84 13 411	○	13,5W	3000K (1110 lm)	12°
84 13 413	○	13,5W	3000K (1060 lm)	26°
84 13 418	○	13,5W	3000K (940 lm)	40°
84 13 417	○	13,5W	3000K (920 lm)	Elliptical
84 13 461	○	13,5W	4000K (1150 lm)	12°
84 13 463	○	13,5W	4000K (1100 lm)	26°
84 13 468	○	13,5W	4000K (980 lm)	40°
84 13 467	○	13,5W	4000K (960 lm)	Elliptical

LED BIANCO - 220-240V 50/60Hz \square
LED Data= 3000K (1485 lm) - 4000K (1545 lm)

50 80 019	○	13,5W	3000K (598 lm)	Asymmetric
50 80 069	○	13,5W	4000K (622 lm)	Asymmetric

ACCESSORIES

89 45 060	●	Recessed box AISI 304 stainless steel
89 17 014	●	IP68 connector for 3x1,5 mm ² cable
89 17 004	●	IP68 IN/OUT connector for 3x4 mm ² cable

TETRA CONTINUO



IP67, IK 10
Walk over 500 Kg

LED white: 1 m cable length

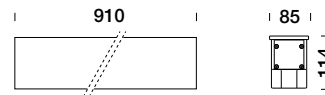

18 LED white - 220-240V 50/60Hz \oplus
LED Data= 3000K (2250 lm) - 4000K (2340 lm)

84 18 511	⦿	18,5W	3000K (1700 lm)	12°
84 18 513	⦿	18,5W	3000K (1600 lm)	26°
84 18 518	⦿	18,5W	3000K (1425 lm)	40°
84 18 517	⦿	18,5W	3000K (1400 lm)	Elliptical
84 18 561	⦿	18,5W	4000K (1765 lm)	12°
84 18 563	⦿	18,5W	4000K (1660 lm)	26°
84 18 568	⦿	18,5W	4000K (1480 lm)	40°
84 18 567	⦿	18,5W	4000K (1455 lm)	Elliptical

ACCESSORIES

89 45 080	●	Recessed box AISI 304 stainless steel
89 17 014	●	IP68 connector for 3x1,5 mm ² cable
89 17 004	●	IP68 IN/OUT connector for 3x4 mm ² cable

MICRO full inox



IP68 Full Dry (2m), IK 10
Drive over 2000 Kg

LED white 220-240V: 0,5 m cable length
LED white 24V: 5 m cable length
LED RGBW: 1 m cable length

platek.eu/MICROfullinox

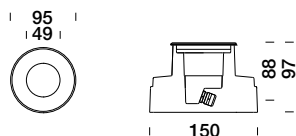

3 LED white - 220-240V 0/50/60Hz
TRIAC dimmable
LED Data= 3000K (565 lm) - 4000K (562 lm)

84 79 911	●	5,9W	3000K (465 lm)	12°
84 79 913	●	5,9W	3000K (435 lm)	33°
84 79 918	○	5,9W	3000K (440 lm)	44°
84 79 961	○	5,9W	4000K (485 lm)	12°
84 79 963	○	5,9W	4000K (450 lm)	33°
84 79 968	○	5,9W	4000K (460 lm)	44°

3 LED white - 24V DC
(power supply to be ordered separately)
LED Data= 3000K (540 lm) - 4000K (562 lm)

84 79 111	○	5,9W	3000K (465 lm)	12°
84 79 113	○	5,9W	3000K (435 lm)	33°
84 79 118	○	5,9W	3000K (440 lm)	44°
84 79 161	○	5,9W	4000K (485 lm)	12°
84 79 163	○	5,9W	4000K (450 lm)	33°
84 79 168	○	5,9W	4000K (460 lm)	44°

4 LED RGBW - 500mA
(power supply to be ordered separately)

83 79 101	○	5,8W	RGBW	12°
83 79 103	○	5,8W	RGBW	33°
83 79 108	○	5,8W	RGBW	44°

ACCESSORIES

89 45 035	●	Recessed box H. 100 mm
89 45 036	●	Recessed box H. 100 mm with base Ø 150 mm
89 45 037	●	Recessed box H. 97 mm with square base 200 mm
89 17 012	●	IP68 connector for 4x1,5 mm ² cable
89 17 014	●	IP68 connector for 3x1,5 mm ² cable
89 17 004	●	IP68 IN/OUT connector for 3x4 mm ² cable
89 18 015	●	Sandblasted glass
89 56 104	●	IP20 Power supply (24V DC - 30W)
89 56 307	●	IP20 Power supply (24V DC - 75W)
89 56 172	●	IP67 Power supply (24V DC - 30W)
89 56 127	●	IP67 Power supply (24V DC - 75W)
89 56 074	●	IP67 Power supply (24V DC - 150W)
ON/OFF		Further power supplies are available on page 105
RGBW		Control systems for dynamic light on page 102

MICRO

Asymmetric



IP68 Full Dry (2m), IK 10
Drive over 2000 Kg

LED white: 0,5 m cable length
LED white Asymmetric: 1 m cable length
LED RGBW: 1 m cable length

platek.eu/MICRO

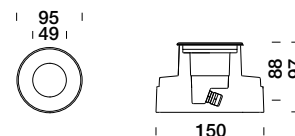

3 LED white - 220-240V 0/50/60Hz
TRIAC dimmable
LED Data= 3000K (565 lm) - 4000K (593 lm)

84 01 911	●	5,9W	3000K (465 lm)	12°
84 01 913	●	5,9W	3000K (435 lm)	33°
84 01 918	○	5,9W	3000K (440 lm)	44°
84 01 961	○	5,9W	4000K (485 lm)	12°
84 01 963	○	5,9W	4000K (450 lm)	33°
84 01 968	○	5,9W	4000K (460 lm)	44°

1 LED white - 700mA
(power supply to be ordered separately)
LED Data= 3000K (250 lm) - 4000K (260 lm)

84 01 019	●	2W	3000K (125 lm)	Asymmetric
84 01 069	○	2W	4000K (130 lm)	Asymmetric

4 LED RGBW - 500mA
(power supply to be ordered separately)

83 01 101	○	5,8W	RGBW	12°
83 01 103	○	5,8W	RGBW	33°
83 01 108	○	5,8W	RGBW	44°

ACCESSORIES

89 45 035	●	Recessed box H. 100 mm
89 45 036	●	Recessed box H. 100 mm with base Ø 150 mm
89 45 037	●	Recessed box H. 97 mm with square base 200 mm
89 17 013	●	IP68 Micro Paguro connector for 2x1,5 mm ² cable
89 17 014	●	IP68 connector for 3x1,5 mm ² cable
89 17 004	●	IP68 IN/OUT connector for 3x4 mm ² cable
89 18 015	●	Sandblasted glass
89 56 054	●	IP67 Power supply (500mA - 6W)
89 56 047	●	IP67 Power supply (500mA - 15W)
89 56 090	●	IP67 Power supply (700mA - 14W)
89 56 117	●	IP67 Power supply (700mA - 30W)
ON/OFF		Further power supplies are available on page 105
RGBW		Control systems for dynamic light on page 102

MINI full inox



IP68 Full Dry (2m), IK 10
Drive over 2000 Kg

LED white 220-240V: 1 m cable length
LED white 24V DC: 5 m cable length
LED RGBW: 1 m cable length

platek.eu/MINIfullinox

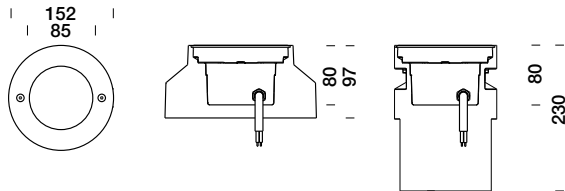

6 LED white - 220-240V 0/50/60Hz

TRIAC dimmable

LED Data= 3000K (1128 lm) - 4000K (1173 lm)

84 80 611	●	11W	3000K (955 lm)	9°
84 80 613	●	11W	3000K (855 lm)	28°
84 80 618	○	11W	3000K (775 lm)	44°
84 80 661	○	11W	4000K (965 lm)	9°
84 80 663	○	11W	4000K (890 lm)	28°
84 80 668	○	11W	4000K (805 lm)	44°

6 LED white - 24V DC (power supply to be ordered separately)

LED Data= 3000K (1128 lm) - 4000K (1173 lm)

84 80 211	●	11W	3000K (955 lm)	9°
84 80 213	●	11W	3000K (855 lm)	28°
84 80 218	○	11W	3000K (775 lm)	44°
84 80 261	○	11W	4000K (995 lm)	9°
84 80 263	○	11W	4000K (890 lm)	28°
84 80 268	○	11W	4000K (800 lm)	44°

8 LED RGBW - 500mA (power supply to be ordered separately)

83 80 201	○	11,5W	RGBW	9°
83 80 203	○	11,5W	RGBW	28°
83 80 208	○	11,5W	RGBW	44°

ACCESSORIES

89 45 015	●	Recessed box H. 100 mm with square base 200 mm
89 45 020	●	Recessed box H. 230 mm
89 17 014	●	IP68 connector for 3x1,5 mm ² cable
89 17 004	●	IP68 IN/OUT connector for 3x4 mm ² cable
89 17 012	●	IP68 connector for 4x1,5 mm ² cable
89 18 750	●	Elliptical filter
89 18 755	●	Sandblasted filter
89 56 104	●	IP20 Power supply (24V DC - 30W)
89 56 307	●	IP20 Power supply (24V DC - 75W)
89 56 172	●	IP67 Power supply (24V DC - 30W)
89 56 127	●	IP67 Power supply (24V DC - 75W)
89 56 074	●	IP67 Power supply (24V DC - 150W)

ON/OFF Further power supplies are available on page 105
RGBW Control systems for dynamic light on page 102

● Product available in stock

○ Product available on request

MINI full inox

Asymmetric



IP68 Full Dry (2m), IK 10
Drive over 2000 Kg

LED white: 1 m cable length

platek.eu/MINIfullinox

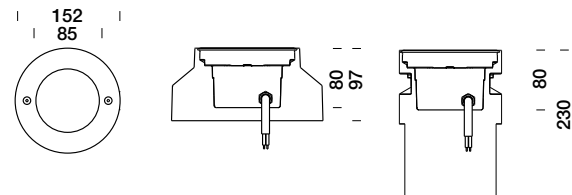

6 LED white - 220-240V 0/50/60Hz

TRIAC dimmable

LED Data= 3000K (1128 lm) - 4000K (1173 lm)

84 80 619	●	11W	3000K (880 lm)	Asymmetric
84 80 669	○	11W	4000K (915 lm)	Asymmetric

ACCESSORIES

89 45 015	●	Recessed box H. 100 mm with square base 200 mm
89 45 020	●	Recessed box H. 230 mm
89 17 014	●	IP68 connector for 3x1,5 mm ² cable
89 17 004	●	IP68 IN/OUT connector for 3x4 mm ² cable

● Product available on request until the end of stocks

MINI

RGBW



IP68 (2m), IK 10
Drive over 2500 Kg

available colours
.01 black

LED white 220-240V: 1 m cable length
LED white 24V DC: 1 m cable length
LED RGBW: 1 m cable length

platek.eu/MINI

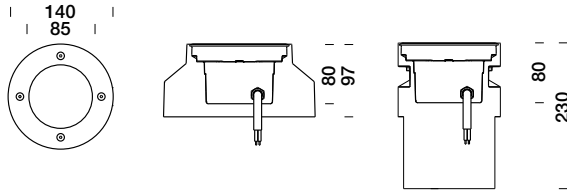

6 LED white - 220-240V 0/50/60Hz
TRIAC dimmable
LED Data= 3000K (1128 lm) - 4000K (1173 lm)

84 02 611	●	11W	3000K (955 lm)	9°
84 02 613	●	11W	3000K (855 lm)	28°
84 02 618	○	11W	3000K (775 lm)	44°
84 02 661	○	11W	4000K (995 lm)	9°
84 02 663	○	11W	4000K (890 lm)	28°
84 02 668	○	11W	4000K (805 lm)	44°

6 LED white - 24V DC - (power supply to be ordered separately)
LED Data= 3000K (1128 lm) - 4000K (1173 lm)

84 02 411	○	11W	3000K (955 lm)	9°
84 02 413	○	11W	3000K (855 lm)	28°
84 02 418	○	11W	3000K (775 lm)	44°
84 02 461	○	11W	4000K (995 lm)	9°
84 02 463	○	11W	4000K (890 lm)	28°
84 02 468	○	11W	4000K (805 lm)	44°

8 LED RGBW - 500mA - (power supply to be ordered separately)

83 02 201	○	11,5W	RGBW	9°
83 02 203	○	11,5W	RGBW	28°
83 02 208	○	11,5W	RGBW	44°

ACCESSORIES

89 45 015	●	Recessed box H. 100 mm with square base 200 mm
89 45 020	●	Recessed box H. 230 mm
89 17 014	●	IP68 connector for 3x1,5 mm ² cable
89 17 004	●	IP68 IN/OUT connector for 3x4 mm ² cable
89 17 012	●	IP68 connector for 4x1,5 mm ² cable
89 18 750	●	Elliptical filter
89 18 755	●	Sandblasted filter
89 56 104	●	IP20 Power supply (24V DC - 30W)
89 56 307	●	IP20 Power supply (24V DC - 75W)
89 56 172	●	IP67 Power supply (24V DC - 30W)
89 56 127	●	IP67 Power supply (24V DC - 75W)
89 56 074	●	IP67 Power supply (24V DC - 150W)

ON/OFF Further power supplies are available on page 105
RGBW Control systems for dynamic light on page 102

MINI

Asymmetric



IP68 (2m), IK 10
Drive over 2500 Kg

available colours
.01 black

LED white: 1 m cable length

platek.eu/MINI

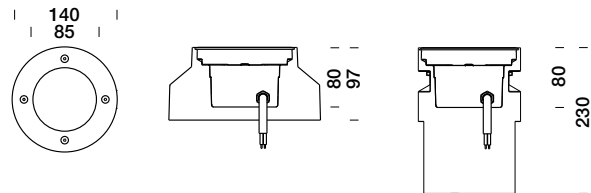

6 LED white - 220-240V 0/50/60Hz
TRIAC dimmable
LED Data= 3000K (1128 lm) - 4000K (1173 lm)

84 02 619	●	11W	3000K (880 lm)	Asymmetric
84 02 669	○	11W	4000K (915 lm)	Asymmetric

ACCESSORIES

89 45 015	●	Recessed box H. 100 mm with square base 200 mm
89 45 020	●	Recessed box H. 230 mm
89 17 014	●	IP68 connector for 3x1,5 mm ² cable
89 17 004	●	IP68 IN/OUT connector for 3x4 mm ² cable

MINI stainless steel ring

MINI stainless steel ring

RGBW

Asymmetric



IP68 (2m), IK 10
Drive over 2500 Kg

IP68 (2m), IK 10
Drive over 2500 Kg

LED white 220-240V: 1 m cable length
LED white 24V DC: 1 m cable length
LED RGBW: 1 m cable length

LED white
1 m cable length

platek.eu/MINI

platek.eu/MINI

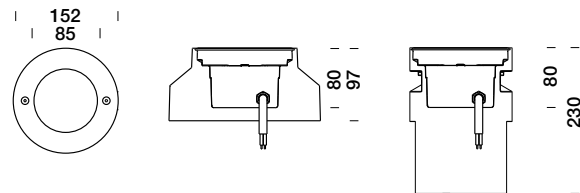
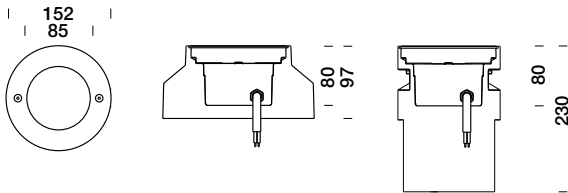

6 LED white - 220-240V 0/50/60Hz
TRIAC dimmable
LED Data= 3000K (1128 lm) - 4000K (1173 lm)

- 84 03 619 ● 11W 3000K (880 lm) Asymmetric
- 84 03 669 ○ 11W 4000K (915 lm) Asymmetric

6 LED white - 220-240V 0/50/60Hz
TRIAC dimmable
LED Data= 3000K (1128 lm) - 4000K (1173 lm)

84 03 611	●	11W	3000K (955 lm)	9°
84 03 613	●	11W	3000K (855 lm)	28°
84 03 618	○	11W	3000K (775 lm)	44°
84 03 661	○	11W	4000K (995 lm)	9°
84 03 663	○	11W	4000K (890 lm)	28°
84 03 668	○	11W	4000K (805 lm)	44°

6 LED white - 24V DC (power supply to be ordered separately)
LED Data= 3000K (1128 lm) - 4000K (1173 lm)

84 03 411	○	11W	3000K (955 lm)	9°
84 03 413	○	11W	3000K (855 lm)	28°
84 03 418	○	11W	3000K (775 lm)	44°
84 03 461	○	11W	4000K (995 lm)	9°
84 03 463	○	11W	4000K (890 lm)	28°
84 03 468	○	11W	4000K (805 lm)	44°

8 LED RGBW - 500mA (power supply to be ordered separately)

83 03 201	○	11,5W	RGBW	9°
83 03 203	○	11,5W	RGBW	28°
83 03 208	○	11,5W	RGBW	44°

ACCESSORIES

ACCESSORIES

- 89 45 015 ● Recessed box H. 100 mm with square base 200 mm
- 89 45 020 ● Recessed box H. 230 mm
- 89 17 014 ● IP68 connector for 3x1,5 mm² cable
- 89 17 004 ● IP68 IN/OUT connector for 3x4 mm² cable
- 89 17 012 ● IP68 connector for 4x1,5 mm² cable
- 89 18 750 ● Elliptical filter
- 89 18 755 ● Sandblasted filter
- 89 56 104 ● IP20 Power supply (24V DC - 30W)
- 89 56 307 ● IP20 Power supply (24V DC - 75W)
- 89 56 172 ● IP67 Power supply (24V DC - 30W)
- 89 56 127 ● IP67 Power supply (24V DC - 75W)
- 89 56 074 ● IP67 Power supply (24V DC - 150W)

- 89 45 015 ● Recessed box H. 100 mm with square base 200 mm
- 89 45 020 ● Recessed box H. 230 mm
- 89 17 014 ● IP68 connector for 3x1,5 mm² cable
- 89 17 004 ● IP68 IN/OUT connector for 3x4 mm² cable

ON/OFF Further power supplies are available on page 105
RGBW Control systems for dynamic light on page 102

MEDIO full inox

RGBW



IP68 Full Dry (2m), IK 10
Walk over 1500 Kg

LED white 24V DC: 5 m cable length
LED RGBW: 5 m cable length

platek.eu/MEDIOfullinox

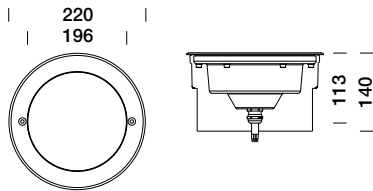

9 LED white - 24V DC

(power supply to be ordered separately)
LED Data= 3000K (1692 lm) - 4000K (1760 lm)

84 81 311	●	15W	3000K (1475 lm)	9°
84 81 313	●	15W	3000K (1325 lm)	28°
84 81 318	○	15W	3000K (1140 lm)	45°
84 81 317	○	15W	3000K (1170 lm)	Elliptical
84 81 361	○	15W	4000K (1535 lm)	9°
84 81 363	○	15W	4000K (1375 lm)	28°
84 81 368	○	15W	4000K (1185 lm)	45°
84 81 367	○	15W	4000K (1220 lm)	Elliptical

16 LED RGBW - 350mA

(power supply to be ordered separately)

83 81 401	○	16W	RGBW	9°
83 81 403	○	16W	RGBW	28°
83 81 408	○	16W	RGBW	45°
83 81 407	○	16W	RGBW	Elliptical

ACCESSORIES

89 45 029	●	Recessed box H. 140 mm
89 17 004	●	IP68 IN/OUT connector for 3x4 mm ² cable
89 17 014	●	IP68 connector for 3x1,5 mm ² cable
89 56 104	●	IP20 Power supply (24V DC - 30W)
89 56 307	●	IP20 Power supply (24V DC - 75W)
89 56 172	●	IP67 Power supply (24V DC - 30W)
89 56 127	●	IP67 Power supply (24V DC - 75W)
89 56 074	●	IP67 Power supply (24V DC - 150W)

ON/OFF Further power supplies are available on page 105
RGBW Control systems for dynamic light on page 102

MEDIO

RGBW



IP68 Full Dry (2m), IK 10
Drive over 2000 Kg

available colours
.01 black

LED white: 1 m cable length
LED RGBW: 2,5 m cable length

platek.eu/MEDIO

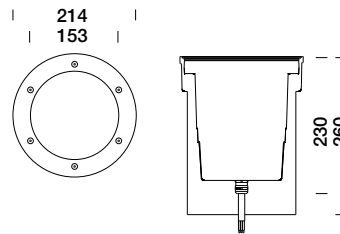

COB LED white - 220-240V 50/60Hz

LED Data= 3000K (2400 lm) - 4000K (2496 lm)

80 30 511	●	20W	3000K (1655 lm)	18°
80 30 513	●	20W	3000K (2135 lm)	44°
80 30 561	○	20W	4000K (1720 lm)	18°
80 30 563	○	20W	4000K (2220 lm)	44°

COB LED white - 220-240V 50/60Hz

LED Data= 3000K (3200 lm) - 4000K (3330 lm)

80 30 711	●	27W	3000K (2320 lm)	18°
80 30 713	●	27W	3000K (2990 lm)	44°
80 30 761	○	27W	4000K (2410 lm)	18°
80 30 763	○	27W	4000K (3110 lm)	44°

9 LED white - 220-240V 50/60Hz

LED Data= 3000K (2250 lm) - 4000K (2340 lm)

84 05 311	●	22W	3000K (2000 lm)	9°
84 05 313	●	22W	3000K (1950 lm)	28°
84 05 318	○	22W	3000K (1780 lm)	45°
84 05 361	○	22W	4000K (2080 lm)	9°
84 05 363	○	22W	4000K (2030 lm)	28°
84 05 368	○	22W	4000K (1850 lm)	45°

16 LED RGBW - 350mA (power supply to be ordered separately)

83 05 401	○	16W	RGBW	9°
83 05 403	○	16W	RGBW	28°
83 05 408	○	16W	RGBW	45°

ACCESSORIES

89 45 030	●	Recessed box H. 260 mm
89 17 004	●	IP68 IN/OUT connector for 3x4 mm ² cable
89 17 014	●	IP68 connector for 3x1,5 mm ² cable
89 18 610	●	Anti-slip glass
89 18 650	●	Elliptical filter
89 18 655	●	Sandblasted filter

RGBW Control systems for dynamic light on page 102

MEDIO

Asymmetric



IP68 Full Dry (2m), IK 10
Drive over 2000 Kg

available colours
.01 black

LED white: 1 m cable length

platek.eu/MEDIO

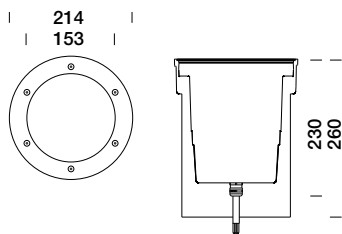

LED white - 220-240V 50/60Hz \oplus
LED Data= 3000K (2250 lm) - 4000K (2340 lm)

84 05 319	●	22W	3000K (1545 lm)	Asymmetric
84 05 369	○	22W	4000K (1605 lm)	Asymmetric

ACCESSORIES

89 45 030	●	Recessed box H. 260 mm
89 17 004	●	IP68 IN/OUT connector for 3x4 mm ² cable
89 17 014	●	IP68 connector for 3x1,5 mm ² cable
89 18 610	●	Anti-slip glass
89 18 655	●	Sandblasted filter

MEDIO stainless steel ring

MEDIO stainless steel ring

RGBW



Asymmetric



IP68 Full Dry (2m), IK 10
Drive over 2000 Kg

LED white: 1 m cable length
LED RGBW: 2,5 m cable length

platek.eu/MEDIO

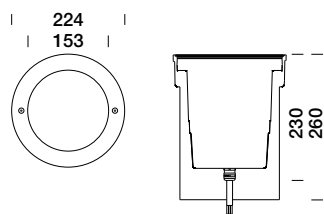

COB LED white - 220-240V 50/60Hz \oplus
LED Data= 3000K (2400 lm) - 4000K (2496 lm)

80 61 511	●	20W	3000K (1655 lm)	18°
80 61 513	●	20W	3000K (2135 lm)	44°
80 61 561	○	20W	4000K (1720 lm)	18°
80 61 563	○	20W	4000K (2220 lm)	44°

COB LED white - 220-240V 50/60Hz \oplus
LED Data= 3000K (3200 lm) - 4000K (3328 lm)

80 61 711	●	27W	3000K (2320 lm)	18°
80 61 713	●	27W	3000K (2990 lm)	44°
80 61 761	○	27W	4000K (2410 lm)	18°
80 61 763	○	27W	4000K (3110 lm)	44°

9 LED white - 220-240V 50/60Hz \oplus
LED Data= 3000K (2250 lm) - 4000K (2340 lm)

84 06 311	●	22W	3000K (2000 lm)	9°
84 06 313	●	22W	3000K (1950 lm)	28°
84 06 318	○	22W	3000K (1780 lm)	45°
84 06 361	○	22W	4000K (2080 lm)	9°
84 06 363	○	22W	4000K (2030 lm)	28°
84 06 368	○	22W	4000K (1850 lm)	45°

16 LED RGBW - 350mA \diamond
(power supply to be ordered separately)

83 06 401	○	16W	RGBW	9°
83 06 403	○	16W	RGBW	28°
83 06 408	○	16W	RGBW	45°

ACCESSORIES

89 45 030	●	Recessed box H. 260 mm
89 17 004	●	IP68 IN/OUT connector for 3x4 mm ² cable
89 17 014	●	IP68 connector for 3x1,5 mm ² cable
89 18 615	●	Anti-slip glass
89 18 650	●	Elliptical filter
89 18 655	●	Sandblasted filter
RGBW		Control systems for dynamic light on page 102

IP68 Full Dry (2m), IK 10
Drive over 2000 Kg

LED white: 1 m cable length

platek.eu/MEDIO

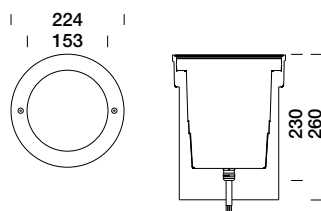

LED white - 220-240V 50/60Hz \oplus
LED Data= 3000K (2250 lm) - 4000K (2340 lm)

84 06 319	●	22W	3000K (1545 lm)	Asymmetric
84 06 369	○	22W	4000K (1605 lm)	Asymmetric

ACCESSORIES

89 45 030	●	Recessed box H. 260 mm
89 17 004	●	IP68 IN/OUT connector for 3x4 mm ² cable
89 17 014	●	IP68 connector for 3x1,5 mm ² cable
89 18 615	●	Anti-slip glass
89 18 655	●	Sandblasted filter

ATLANTIQUE

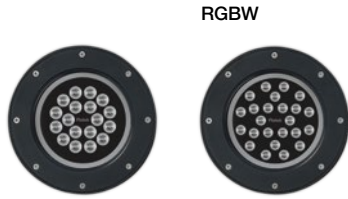

RGBW

IP68 Full Dry (2m), IK 10
Drive over 2500 Kg

available colours
.01 black

LED white: 3 m cable length
LED RGBW: 2,5 m cable length

platek.eu/ATLANTIQUE

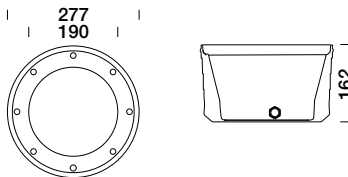

18 LED white - 220-240V 50/60Hz \oplus
LED Data= 3000K (3385 lm) - 4000K (3520 lm)

84 33 511	○	32W	3000K (2780 lm)	9°
84 33 513	○	32W	3000K (2735 lm)	28°
84 33 518	○	32W	3000K (2330 lm)	45°
84 33 517	○	32W	3000K (2440 lm)	Elliptical
84 33 561	○	32W	4000K (2890 lm)	9°
84 33 563	○	32W	4000K (2845 lm)	28°
84 33 568	○	32W	4000K (2425 lm)	45°
84 33 567	○	32W	4000K (2540 lm)	Elliptical

24 LED RGBW - 500mA \diamond
(power supply to be ordered separately)

83 33 501	○	35W	RGBW	9°
83 33 503	○	35W	RGBW	28°
83 33 508	○	35W	RGBW	45°
83 33 507	○	35W	RGBW	Elliptical

ACCESSORIES

89 36 000	●	Recessed box H. 162 mm
89 18 205	●	Anti-slip glass
89 17 014	●	IP68 connector for 3x1,5 mm ² cable
89 17 004	●	IP68 IN/OUT connector for 3x4 mm ² cable
89 20 000	●	Stainless steel ring
RGBW		Control systems for dynamic light on page 102

GRANDE



RGBW

IP68 Full Dry (2m), IK 10
Drive over 2500 Kg

available colours
.01 black

LED white: 3 m cable length
LED RGBW: 3,5 m cable length

platek.eu/GRANDE

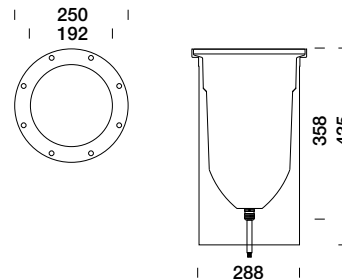

18 LED white - 220-240V 50/60Hz \oplus
(recessed box to be ordered separately)
LED Data= 3000K (3960 lm) - 4000K (4118 lm)

84 08 511	○	44W	3000K (3675 lm)	9°
84 08 513	○	44W	3000K (3645 lm)	28°
84 08 518	○	44W	3000K (3080 lm)	45°
84 08 517	○	44W	3000K (3250 lm)	Elliptical
84 08 561	○	44W	4000K (3820 lm)	9°
84 08 563	○	44W	4000K (3790 lm)	28°
84 08 568	○	44W	4000K (3205 lm)	45°
84 08 567	○	44W	4000K (3385 lm)	Elliptical

24 LED RGBW - 700mA \diamond
(power supply and recessed box to be ordered separately)

83 08 501	○	48,5W	RGBW	9°
83 08 503	○	48,5W	RGBW	28°
83 08 508	○	48,5W	RGBW	45°
83 08 507	○	48,5W	RGBW	Elliptical

ACCESSORIES

89 45 010	●	Recessed box H. 435 mm
89 18 205	●	Anti-slip glass
89 17 014	●	IP68 connector for 3x1,5 mm ² cable
89 17 004	●	IP68 IN/OUT connector for 3x4 mm ² cable
RGBW		Control systems for dynamic light on page 102

TETRA INCASSO 900 - 0°÷15° tiltable

TETRA INCASSO 900



IP67, IK 10
Drive over 2000 Kg

LED white: 1 m cable length
LED RGBW: 1 m cable length

platek.eu/TETRA-INCASSO

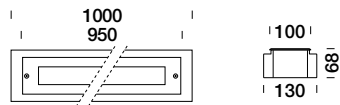

18 LED white - 220-240V 50/60Hz ⊕
LED Data= 3000K (2250 lm) - 4000K (2340 lm)

84 96 511	○	21W	3000K (1700 lm)	12°
84 96 513	○	21W	3000K (1600 lm)	26°
84 96 518	○	21W	3000K (1425 lm)	40°
84 96 517	○	21W	3000K (1400 lm)	Elliptical
84 96 561	○	21W	4000K (1765 lm)	12°
84 96 563	○	21W	4000K (1660 lm)	26°
84 96 568	○	21W	4000K (1480 lm)	40°
84 96 567	○	21W	4000K (1455 lm)	Elliptical

24 LED RGBW - 500mA ⚡
(power supply to be ordered separately)

83 96 501	○	35W	RGBW	12°
83 96 503	○	35W	RGBW	26°
83 96 508	○	35W	RGBW	40°
83 96 507	○	35W	RGBW	Elliptical

ACCESSORIES

89 45 065	●	Recessed box AISI 304 stainless steel
89 17 014	●	IP68 connector for 3x1,5 mm ² cable
89 17 004	●	IP68 IN/OUT connector for 3x4 mm ² cable

RGBW Control systems for dynamic light on page 102

IP67, IK 10
Drive over 2000 Kg

LED white: 1 m cable length
LED RGBW: 1 m cable length

platek.eu/TETRA-INCASSO

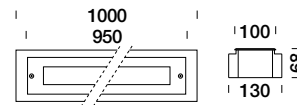

36 LED white - 220-240V 50/60Hz ⊕
LED Data= 3000K (4500 lm) - 4000K (4680 lm)

84 12 611	○	47W	3000K (3400 lm)	12°
84 12 613	○	47W	3000K (3200 lm)	26°
84 12 618	○	47W	3000K (2850 lm)	40°
84 12 617	○	47W	3000K (2800 lm)	Elliptical
84 12 661	○	47W	4000K (3535 lm)	12°
84 12 663	○	47W	4000K (3320 lm)	26°
84 12 668	○	47W	4000K (2960 lm)	40°
84 12 667	○	47W	4000K (1910 lm)	Elliptical

36 LED white - 220-240V 50/60Hz ⊕
LED Data= 3000K (4455 lm) - 4000K (4633 lm)

50 80 319	○	47W	3000K (1725 lm)	Asymmetric
50 80 369	○	47W	4000K (1800 lm)	Asymmetric

ACCESSORIES

89 45 065	●	Recessed box AISI 304 stainless steel
89 17 014	●	IP68 connector for 3x1,5 mm ² cable
89 17 004	●	IP68 IN/OUT connector for 3x4 mm ² cable

NANO full inox roll over



IP68 Full Dry (2m), IK 10
Walk over 500 Kg

0,5 m cable length

platek.eu/NANOINOX-RO

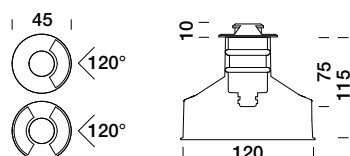

NANO full inox 1 opening

1 LED white - 350mA

(power supply and recessed box to be ordered separately)

LED Data= 3000K (125 lm) - 4000K (131 lm)

84 34 011	●	1W	3000K (10 lm)	1 opening
84 34 061	○	1W	4000K (10 lm)	1 opening

NANO full inox 2 openings

1 LED white - 350mA

(power supply and recessed box to be ordered separately)

LED Data= 3000K (125 lm) - 4000K (131 lm)

84 34 012	●	1W	3000K (10 lm)	2 openings
84 34 062	○	1W	4000K (10 lm)	2 openings

ACCESSORI

89 45 033	●	Recessed box H. 75 mm
89 45 038	●	Recessed box H. 115 mm with base Ø 120 mm
89 45 039	●	Recessed box IP67 H. 160 mm with base Ø 120 mm
89 17 006	●	IP68 connector for 2x0,75 mm ² cable
89 17 013	●	IP68 Micro Paguro connector for 2x1,5 mm ² cable
89 56 069	●	IP67 Power supply (350mA - 6W)
89 56 059	●	IP67 Power supply (350mA - 15W)

ON/OFF Further power supplies are available on page 105

● Product available in stock

○ Product available on request

MICRO full inox roll over



IP68 Full Dry (2m), IK 10
Walk over 2000 Kg

0,5 m cable length

platek.eu/MICROINOX-RO

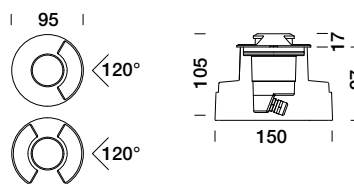

MICRO full inox 1 opening

1 LED white - 220-240V 50/60Hz

LED Data= 3000K (188 lm) - 4000K (195 lm)

84 79 011	●	2,9W	3000K (15 lm)	1 opening
84 79 061	○	2,9W	4000K (15 lm)	1 opening

MICRO full inox 2 openings

1 LED white - 220-240V 50/60Hz

LED Data= 3000K (188 lm) - 4000K (195 lm)

84 79 012	●	2,9W	3000K (30 lm)	2 openings
84 79 062	○	2,9W	4000K (30 lm)	2 openings

ACCESSORIES

89 45 035	●	Recessed box H. 100 mm
89 45 036	●	Recessed box H. 100 mm with base Ø 150 mm
89 45 037	●	Recessed box H. 97 mm with square base 200 mm
89 17 014	●	IP68 connector for 3x1,5 mm ² cable
89 17 004	●	IP68 IN/OUT connector for 3x4 mm ² cable

● Product available on request until the end of stocks

MINI roll over



IP68 Full Dry (2m), IK 10
Drive over 2000 Kg

LED white: 1 m cable length

platek.eu/MINI-RO

available colours

.01 black

other colours available on request with no price increase

.02 white; .06 grey; .07 corten;
.08 anthracite; .09 bronze

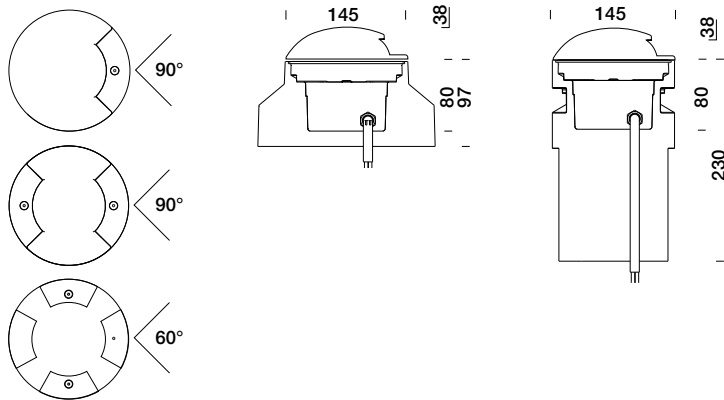

MINI 1 opening - H. 97 mm

1 LED white - 220-240V 0/50/60Hz ⊕

LED Data= 3000K (165 lm) - 4000K (172 lm)

84 09 016	●	2,5W	3000K (85 lm)	1 opening
84 09 066	○	2,5W	4000K (90 lm)	1 opening

MINI 2 openings - H. 97 mm

2 LED white - 220-240V 0/50/60Hz ⊕

LED Data= 3000K (330 lm) - 4000K (343 lm)

84 09 716	●	4,2W	3000K (175 lm)	2 openings
84 09 766	○	4,2W	4000K (185 lm)	2 openings

MINI 4 openings - H. 97 mm

4 LED white - 220-240V 0/50/60Hz ⊕

LED Data= 3000K (660 lm) - 4000K (686 lm)

84 09 816	●	7,4W	3000K (355 lm)	4 openings
84 09 866	○	7,4W	4000K (370 lm)	4 openings

ACCESSORIES

89 45 015	●	Recessed box H. 100 mm with square base 200 mm
89 45 020	●	Recessed box H. 230 mm
89 45 025	●	Recessed box H. 340 mm
89 17 014	●	IP68 connector for 3x1,5 mm ² cable
89 17 004	●	IP68 IN/OUT connector for 3x4 mm ² cable

MEDIO roll over



IP68 Full Dry (2m), IK 10
Drive over 2000 Kg

LED white: 1 m cable length

platek.eu/MICROINOX-RO

available colours

.01 black

other colours available on request with no price increase

.02 white; .06 grey; .07 corten;
.08 anthracite; .09 bronze

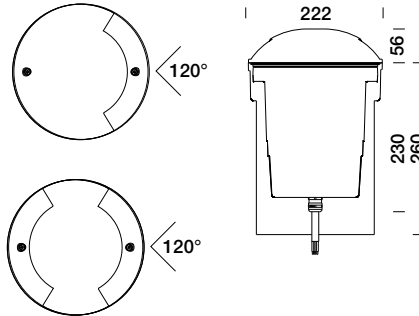

MEDIO 1 opening

2 LED white - 220-240V 0/50/60Hz ⊕

LED Data= 3000K (330 lm) - 4000K (343 lm)

84 10 116	●	4,7W	3000K (110 lm)	1 opening
84 10 166	○	4,7W	4000K (115 lm)	1 opening

MEDIO 2 openings

4 LED white - 220-240V 0/50/60Hz ⊕

LED Data= 3000K (660 lm) - 4000K (686 lm)

84 10 216	●	8,3W	3000K (240 lm)	2 openings
84 10 266	○	8,3W	4000K (250 lm)	2 openings

ACCESSORIES

89 45 030	●	Recessed box H. 260 mm
89 45 031	●	Recessed box H. 325 mm
89 17 014	●	IP68 connector for 3x1,5 mm ² cable
89 17 004	●	IP68 IN/OUT connector for 3x4 mm ² cable

SPY SMALL

design by Rocco Este



IP66, IK 05

LED white: 0,15 m cable length
IP68 connector included

platek.eu/SPY

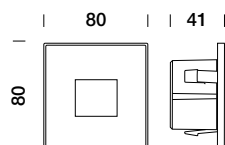

SPY SMALL Transparent glass - Asymmetric
LED white - 220-240V 50/60Hz
(recessed box for concrete and IP67 connector included)
LED Data= 3000K (250 lm) - 4000K (260 lm)

50 02 199	○	3,8W	2700K (25 lm)	Black
50 02 299	○	3,8W	2700K (25 lm)	White
50 02 699	○	3,8W	2700K (25 lm)	Grey
50 02 899	○	3,8W	2700K (25 lm)	Anthracite
50 02 999	○	3,8W	2700K (25 lm)	Bronze
50 02 119	●	3,8W	3000K (25lm)	Black
50 02 219	●	3,8W	3000K (25lm)	White
50 02 619	●	3,8W	3000K (25lm)	Grey
50 02 819	●	3,8W	3000K (25lm)	Anthracite
50 02 919	●	3,8W	3000K (25lm)	Bronze
50 02 169	○	3,8W	4000K (25 lm)	Black
50 02 269	○	3,8W	4000K (25 lm)	White
50 02 669	○	3,8W	4000K (25 lm)	Grey
50 02 869	○	3,8W	4000K (25 lm)	Anthracite
50 02 969	○	3,8W	4000K (25 lm)	Bronze

SPY SMALL Sandblasted glass - Diffuse
LED white - 220-240V 50/60Hz
(recessed box for concrete and IP67 connector included)
LED Data= 3000K (250 lm) - 4000K (260 lm)

50 02 196	○	3,8W	2700K (10 lm)	Black
50 02 296	○	3,8W	2700K (10 lm)	White
50 02 696	○	3,8W	2700K (10 lm)	Grey
50 02 896	○	3,8W	2700K (10 lm)	Anthracite
50 02 996	○	3,8W	2700K (10 lm)	Bronze
50 02 116	○	3,8W	3000K (10 lm)	Black
50 02 216	●	3,8W	3000K (10 lm)	White
50 02 616	●	3,8W	3000K (10 lm)	Grey
50 02 816	○	3,8W	3000K (10 lm)	Anthracite
50 02 916	○	3,8W	3000K (10 lm)	Bronze
50 02 166	○	3,8W	4000K (10 lm)	Black
50 02 266	○	3,8W	4000K (10 lm)	White
50 02 666	○	3,8W	4000K (10 lm)	Grey
50 02 866	○	3,8W	4000K (10 lm)	Anthracite
50 02 966	○	3,8W	4000K (10 lm)	Bronze

ACCESSORIES

89 45 046	●	Recessed box drywalls
89 45 047	●	Recessed box for concrete

SPY MEDIUM

design by Rocco Este



IP66, IK 05

LED white: 0,15 m cable length
IP68 connector included

platek.eu/SPY

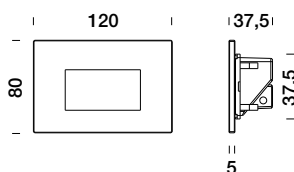

SPY MEDIUM Transparent glass - Asymmetric
LED white - 220-240V 50/60Hz
(recessed box for concrete and IP67 connector included)
LED Data= 3000K (400 lm) - 4000K (416 lm)

50 03 199	○	6W	2700K (130 lm)	Black
50 03 299	○	6W	2700K (130 lm)	White
50 03 699	○	6W	2700K (130 lm)	Grey
50 03 899	○	6W	2700K (130 lm)	Anthracite
50 03 999	○	6W	2700K (130 lm)	Bronze
50 03 119	●	6W	3000K (130 lm)	Black
50 03 219	●	6W	3000K (130 lm)	White
50 03 619	●	6W	3000K (130 lm)	Grey
50 03 819	●	6W	3000K (130 lm)	Anthracite
50 03 919	●	6W	3000K (130 lm)	Bronze
50 03 169	○	6W	4000K (130 lm)	Black
50 03 269	○	6W	4000K (130 lm)	White
50 03 669	○	6W	4000K (130 lm)	Grey
50 03 869	○	6W	4000K (130 lm)	Anthracite
50 03 969	○	6W	4000K (130 lm)	Bronze

SPY MEDIUM Sandblasted glass - Diffuse
LED white - 220-240V 50/60Hz
(recessed box for concrete and IP67 connector included)
LED Data= 3000K (400 lm) - 4000K (416 lm)

50 03 196	○	6W	2700K (50 lm)	Black
50 03 296	○	6W	2700K (50 lm)	White
50 03 696	○	6W	2700K (50 lm)	Grey
50 03 896	○	6W	2700K (50 lm)	Anthracite
50 03 996	○	6W	2700K (50 lm)	Bronze
50 03 116	○	6W	3000K (50 lm)	Black
50 03 216	●	6W	3000K (50 lm)	White
50 03 616	●	6W	3000K (50 lm)	Grey
50 03 816	○	6W	3000K (50 lm)	Anthracite
50 03 916	○	6W	3000K (50 lm)	Bronze
50 03 166	○	6W	4000K (50 lm)	Black
50 03 266	○	6W	4000K (50 lm)	White
50 03 666	○	6W	4000K (50 lm)	Grey
50 03 866	○	6W	4000K (50 lm)	Anthracite
50 03 966	○	6W	4000K (50 lm)	Bronze

ACCESSORIES

89 45 045	●	Recessed box drywalls
89 45 044	●	Recessed box for concrete
89 45 052	●	Surface mounted external box available .01; .02; .06; .08; .09 colour

SPY LARGE

design by Rocco Este

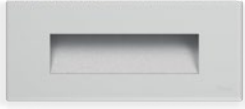

IP66, IK 05

LED white: 0,15 m cable length
IP68 connector included

platek.eu/SPY

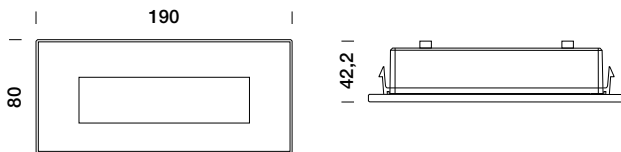

SPY LARGE Transparent glass - Asymmetric

LED white - 220-240V 50/60Hz

(recessed box for concrete and IP67 connector included)

LED Data= 3000K (500 lm) - 4000K (572 lm)

50 04 199	○	8W	2700K (150 lm)	Black
50 04 299	○	8W	2700K (150 lm)	White
50 04 699	○	8W	2700K (150 lm)	Grey
50 04 899	○	8W	2700K (150 lm)	Anthracite
50 04 999	○	8W	2700K (150 lm)	Bronze
50 04 119	●	8W	3000K (150 lm)	Black
50 04 219	●	8W	3000K (150 lm)	White
50 04 619	●	8W	3000K (150 lm)	Grey
50 04 819	●	8W	3000K (150 lm)	Anthracite
50 04 919	●	8W	3000K (150 lm)	Bronze
50 04 169	○	8W	4000K (150 lm)	Black
50 04 269	○	8W	4000K (150 lm)	White
50 04 669	○	8W	4000K (150 lm)	Grey
50 04 869	○	8W	4000K (150 lm)	Anthracite
50 04 969	○	8W	4000K (150 lm)	Bronze

SPY LARGE Sandblasted glass - Diffuse

LED white - 220-240V 50/60Hz

(recessed box for concrete and IP67 connector included)

LED Data= 3000K (550 lm) - 4000K (572 lm)

50 04 196	○	8W	2700K (60 lm)	Black
50 04 296	○	8W	2700K (60 lm)	White
50 04 696	○	8W	2700K (60 lm)	Grey
50 04 896	○	8W	2700K (60 lm)	Anthracite
50 04 996	○	8W	2700K (60 lm)	Bronze
50 04 116	○	8W	3000K (60 lm)	Black
50 04 216	●	8W	3000K (60 lm)	White
50 04 616	●	8W	3000K (60 lm)	Grey
50 04 816	○	8W	3000K (60 lm)	Anthracite
50 04 916	○	8W	3000K (60 lm)	Bronze
50 04 166	○	8W	4000K (60 lm)	Black
50 04 266	○	8W	4000K (60 lm)	White
50 04 666	○	8W	4000K (60 lm)	Grey
50 04 866	○	8W	4000K (60 lm)	Anthracite
50 04 966	○	8W	4000K (60 lm)	Bronze

ACCESSORIES

89 45 049	●	Recessed box for concrete
-----------	---	---------------------------

TEAM SMALL

design by Marco Acerbis



IP66, IK 08

IP68 connector included

platek.eu/TEAM

available colours

.06 grey

other colours available on request with no price increase

.01 black; .02 white; .07 corten; .08 anthracite; .09 bronze

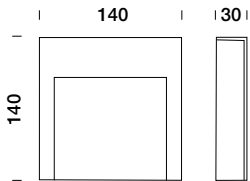

TEAM SMALL

LED white - 220-240V 50/60Hz \oplus

TRIAC dimmable

LED Data= 3000K (800 lm) - 4000K (832 lm)

34 80 119	●	8W	3000K (395 lm)	Asymmetric
34 80 169	○	8W	4000K (415 lm)	Asymmetric

TEAM MEDIUM

design by Marco Acerbis



IP66, IK 08

IP68 connector included

platek.eu/TEAM

available colours

.06 grey

other colours available on request with no price increase

.01 black; .02 white; .07 corten; .08 anthracite; .09 bronze

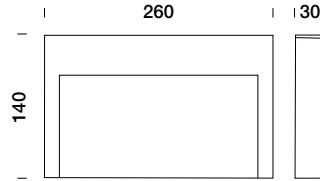

TEAM MEDIUM

LED white - 220-240V 50/60Hz \oplus

TRIAC dimmable

LED Data= 3000K (1600 lm) - 4000K (1664 lm)

34 80 219	●	17,5W	3000K (890 lm)	Asymmetric
34 80 269	○	17,5W	4000K (935 lm)	Asymmetric

ACCESSORIES

89 47 020	●	Rubber for side entry cable (2 PCS)
89 45 122	●	Recessed box drywalls/concrete TEAM small

ACCESSORIES

89 47 020	●	Rubber for side entry cable (2 PCS)
89 45 123	●	Recessed box drywalls/concrete TEAM medium
89 17 021	●	IP68 3-way connector for Ø 6.5 / 12 mm cables max. 3x2.5 mm ² (Basic Paguro)

FRAME



IP65, IK 07

0,20 m cable length

platek.eu/FRAME

available colours

.06 grey; .08 anthracite

other colours available on request with no price increase

.01 black; .02 white;

.07 corten; .09 bronze

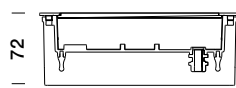
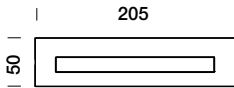

LED white - 220-240V 50/60Hz \oplus
 (recessed box to be ordered separately)
 LED Data= 3000K (420 lm) - 4000K (437 lm)

34 55 911	●	4,8W	3000K (145 lm)	Asymmetric
34 55 916	○	4,8W	4000K (150 lm)	Asymmetric

12V DC version available on request

ACCESSORIES

99 20 050	●	Recessed box
89 17 014	●	IP68 connector for 3x1,5 mm ² cable

● Product available in stock

○ Product available on request

MASK



IP65, IK 07

0,20 m cable length

platek.eu/MASK

available colours

.06 grey

other colours available on request with no price increase

.01 black; .02 white; .07 corten;

.08 anthracite; .09 bronze

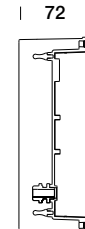
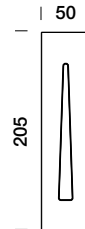

LED white - 12V DC \diamond
 (power supply and recessed box to be ordered separately)
 LED Data= 3000K (220 lm) - 4000K (229 lm)

34 50 601	●	2,8W	3000K (10 lm)	Asymmetric
34 50 606	○	2,8W	4000K (10 lm)	Asymmetric

ACCESSORIES

99 20 050	●	Recessed box
89 17 012	●	IP68 connector for 4x1,5 mm ² cable
89 17 014	●	IP68 connector for 3x1,5 mm ² cable
89 56 109	●	IP20 Power supply (12V DC - 18W) max. 8 products
89 56 091	●	IP67 Power supply (12V DC - 14W) max. 4 products
89 56 103	●	IP67 Power supply (12V DC - 60W) max. 19 products
ON/OFF		Further power supplies are available on page 105

● Product available on request until the end of stocks

PROMENADE

Promenade 40



Promenade 200



IP65, IK 05

platek.eu/PROMENADE

available colours

.06 grey

other colours available on request with no price increase

.01 black; .02 white; .07 corten;

.08 anthracite; .09 bronze

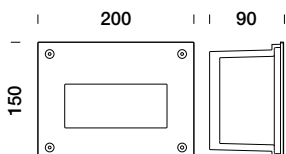

PROMENADE 40

LED white - 220-240V 0/50/60Hz

LED Data= 3000K (495 lm) - 4000K (515 lm)

84 47 119 ● 6W 3000K (170 lm) Asymmetric

84 47 169 ○ 6W 4000K (175 lm) Asymmetric

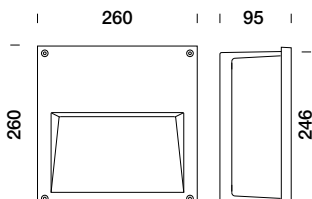

PROMENADE 200

LED white - 220-240V 0/50/60Hz

LED Data= 3000K (1100 lm) - 4000K (1144 lm)

84 48 919 ● 13W 3000K (500 lm) Asymmetric

84 48 969 ○ 13W 4000K (515 lm) Asymmetric

ACCESSORIES

- 99 50 000 ● Recessed box Promenade 40
- 99 40 030 ● Recessed box Promenade 200

● Product available in stock

○ Product available on request

MILANO 2

Milano 2 Frame



Milano 2 Grid



IP65, IK 05

platek.eu/MILANO 2

standard colour

.06 grey

other colours available on request with no price increase

.01 black; .02 white; .07 corten;

.08 anthracite; .09 bronze

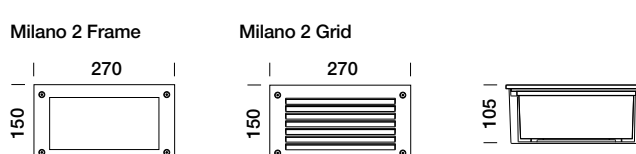

MILANO 2

LED white - 220-240V 0/50/60Hz

LED Data= 3000K (650 lm) - 4000K (676 lm)

34 75 119 ● 7,5W 3000K (440 lm) Diffuse Frame

34 74 119 ● 7,5W 3000K (110 lm) Asymm. Grid

34 75 169 ● 7,5W 4000K (460 lm) Diffuse Frame

34 74 169 ● 7,5W 4000K (115 lm) Asymm. Grid

ACCESSORIES

- 99 40 020 ○ Recessed box

● Product available on request until the end of stocks

FLIC



IP65, IK 05

standard colour
 .06 grey
 other colours available on request with
 no price increase
 .01 black; .02 white; .07 corten;
 .08 anthracite; .09 bronze

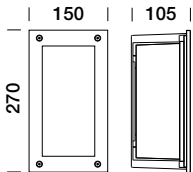

FLIC
 LED white - 220-240V 0/50/60Hz \oplus
 LED Data= 3000K (1000 lm) - 4000K (1040 lm)

34 76 116	●	10W	3000K (540 lm)	Asymmetric
34 76 166	●	10W	4000K (560 lm)	Asymmetric

ACCESSORIES

99 40 020	○	Recessed box
-----------	---	--------------

TARSIUS floodlight design by Piero Castiglioni



IP66, IK 10

0,5 m cable length
 platek.eu/TARSIUS

available colours
 .06 grey
 other colours available on request with
 no price increase
 .01 black; .02 white; .07 corten;
 .08 anthracite; .09 bronze

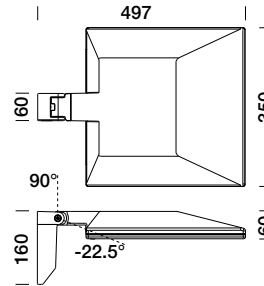

LED white - 220-240V 0/50/60Hz \square
 DALI Dimmable
 LED Data= 3000K (6000 lm) - 4000K (6240 lm)

88 50 918	●	58W	3000K (5115 lm)	Street
88 50 919	●	58W	3000K (4580 lm)	Asymmetric
88 50 968	○	58W	4000K (5320 lm)	Street
88 50 969	○	58W	4000K (4765 lm)	Asymmetric

LED white - 220-240V 0/50/60Hz \square
 Midnight
 LED Data= 3000K (5088 lm) - 4000K (5292 lm)

88 50 718	○	51W	3000K (4245 lm)	Street
88 50 719	○	51W	3000K (4245 lm)	Asymmetric
88 50 768	○	51W	4000K (4415 lm)	Street
88 50 769	○	51W	4000K (4415 lm)	Asymmetric

SUN SMALL floodlight

design by Lundbergdesign



SUN MEDIUM floodlight

design by Lundbergdesign



RGBW



RGBW

Asymmetrical

Street optic



IP66, IK 09

platek.eu/SUN

available colours

.06 grey; .08 anthracite

other colours available on request with no price increase

.01 black; .02 white;

.07 corten; .09 bronze

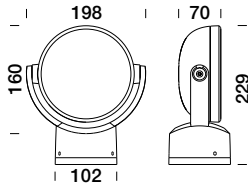

SUN Small

LED white - 220-240V 0/50/60Hz ⊕

DALI Dimmable

LED Data= 3000/4000K (2925 lm)

88 40 111	●	27W	3000K (1070 lm)	14°
88 40 113	●	27W	3000K (1885 lm)	26°
88 40 118	●	27W	3000K (1970 lm)	60°
88 40 161	○	27W	4000K (1070 lm)	14°
88 40 163	○	27W	4000K (1885 lm)	26°
88 40 168	○	27W	4000K (1970 lm)	60°

SUN Small

LED RGBW - max. 900mA - ⬠

(power supply to be ordered separately)

88 40 101	○	20W	RGBW	24°
88 40 103	○	20W	RGBW	40°
88 40 108	○	20W	RGBW	70°

ACCESSORIES

90 05 125	●	AISI 304 stainless steel spike
89 51 035	○	Fixing system for SUN floodlights on Ø 60/76/102 mm poles
RGBW		Control systems for dynamic light on page 102

● Product available in stock

○ Product available on request

IP66, IK 10

platek.eu/SUN

available colours

.06 grey; .08 anthracite

other colours available on request with no price increase

.01 black; .02 white;

.07 corten; .09 bronze

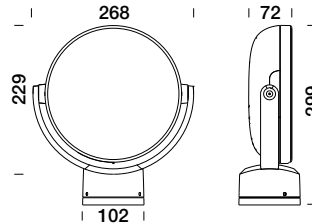

SUN Medium

LED white - 220-240V 0/50/60Hz ⊕

DALI Dimmable

LED Data= 3000/4000K (5000 lm)

88 40 311	●	40W	3000K (2070 lm)	14°
88 40 313	●	40W	3000K (3640 lm)	26°
88 40 318	●	40W	3000K (3800 lm)	60°
88 40 419	●	34W	3000K (2630 lm)	Asymmetric
88 40 418	●	38W	3000K (3490 lm)	Street
88 40 361	○	40W	4000K (2070 lm)	14°
88 40 363	○	40W	4000K (3640 lm)	26°
88 40 368	○	40W	4000K (3800 lm)	60°
88 40 469	○	34W	4000K (2630 lm)	Asymmetric
88 40 468	○	38W	4000K (3490 lm)	Street

SUN Medium

LED RGBW - max. 900mA - ⬠

(power supply to be ordered separately)

88 40 301	○	40W	RGBW	24°
88 40 303	○	40W	RGBW	40°
88 40 308	○	40W	RGBW	70°

ACCESSORIES

90 05 125	●	AISI 304 stainless steel spike
89 51 035	○	Fixing system for SUN floodlights on Ø 60/76/102 mm poles
RGBW		Control systems for dynamic light on page 102

● Product available on request until the end of stocks

SUN LARGE floodlight design by Lundbergdesign



RGBW

Asymmetrical

Street optic



IP66, IK 10

platek.eu/SUN

available colours
.06 grey; .08 anthracite
other colours available on request with
no price increase
.01 black; .02 white;
.07 corten; .09 bronze

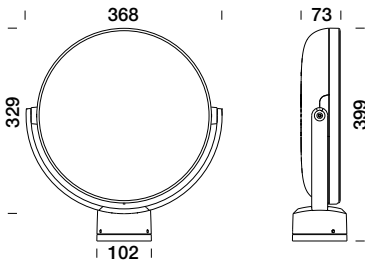

SUN Large
LED white - 220-240V 0/50/60Hz \oplus
DALI Dimmable
LED Data= 3000/4000K (10000 lm)

88 40 611	●	80W	3000K (4140 lm)	14°
88 40 613	●	80W	3000K (7280 lm)	26°
88 40 618	●	80W	3000K (7600 lm)	60°
88 40 719	●	79W	3000K (5090 lm)	Asymmetric
88 40 718	●	76W	3000K (6980 lm)	Street
88 40 661	○	80W	4000K (4140 lm)	14°
88 40 663	○	80W	4000K (7280 lm)	26°
88 40 668	○	80W	4000K (7600 lm)	60°
88 40 769	○	79W	4000K (5090 lm)	Asymmetric
88 40 768	○	76W	4000K (6980 lm)	Street

SUN Large
LED RGBW - max. 900mA - \diamond
(power supply to be ordered separately)

88 40 601	○	80W	RGBW	24°
88 40 603	○	80W	RGBW	40°
88 40 608	○	80W	RGBW	70°

ACCESSORIES

90 05 125	●	AISI 304 stainless steel spike
89 51 035	○	Fixing system for SUN floodlights on Ø 60/76/102 mm poles
RGBW		Control systems for dynamic light on page 102

● Product available in stock

○ Product available on request

● Product available on request until the end of stocks

TARGET SMALL floodlight design by Marco Acerbis



IP66, IK 08

LED white: IP68 connector included
LED RGBW: 2 m cable length

platek.eu/TARGET

available colours

.06 grey

other colours available on request with
no price increase

.01 black; .02 white; .07 corten;
.08 anthracite; .09 bronze

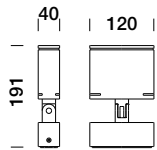

TARGET Small

4 LED white - 220-240V 0/50/60Hz ⊕

LED Data= 3000K (1000 lm) - 4000K (1040 lm)

88 20 111	●	10W	3000K (780 lm)	9°
88 20 113	●	10W	3000K (790 lm)	24°
88 20 118	○	10W	3000K (720 lm)	48°
88 20 117	●	10W	3000K (745 lm)	Elliptical
88 20 161	○	10W	4000K (810 lm)	9°
88 20 163	○	10W	4000K (820 lm)	24°
88 20 168	○	10W	4000K (750 lm)	48°
88 20 167	○	10W	4000K (775 lm)	Elliptical

TARGET Small

4 LED RGBW - 700mA - ⬡

(power supply to be ordered separately)

88 20 101	○	8W	RGBW	9°
88 20 103	○	8W	RGBW	24°
88 20 108	○	8W	RGBW	48°
88 20 107	○	8W	RGBW	Elliptical

ACCESSORIES

90 05 150	●	Spike
89 50 100	●	Extension base H. 300 mm (TARGET small)
89 05 070	●	Visor
89 05 110	●	Deflector
RGBW		Control systems for dynamic light on page 102

TARGET MEDIUM floodlight design by Marco Acerbis



IP66, IK 08

LED white: IP68 connector included
LED RGBW: 2 m cable length

platek.eu/TARGET

available colours

.06 grey

other colours available on request with
no price increase

.01 black; .02 white; .07 corten;
.08 anthracite; .09 bronze

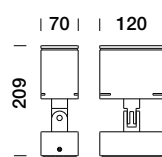

TARGET Medium

8 LED white - 220-240V 0/50/60Hz ⊕

LED Data= 3000K (2000 lm) - 4000K (2080 lm)

88 20 211	●	20W	3000K (1615 lm)	9°
88 20 213	●	20W	3000K (1535 lm)	24°
88 20 218	○	20W	3000K (1365 lm)	48°
88 20 217	●	20W	3000K (1405 lm)	Elliptical
88 20 261	○	20W	4000K (1680 lm)	9°
88 20 263	○	20W	4000K (1600 lm)	24°
88 20 268	○	20W	4000K (1415 lm)	48°
88 20 267	○	20W	4000K (1460 lm)	Elliptical

TARGET Medium

8 LED RGBW - 700mA - ⬡

(power supply to be ordered separately)

88 20 201	○	16W	RGBW	9°
88 20 203	○	16W	RGBW	24°
88 20 208	○	16W	RGBW	48°
88 20 207	○	16W	RGBW	Elliptical

ACCESSORIES

90 05 150	●	Spike
89 50 110	●	Extension base H. 300 mm (TARGET medium)
89 05 071	●	Visor
89 05 111	●	Deflector
RGBW		Control systems for dynamic light on page 102

TARGET LARGE floodlight

design by Marco Acerbis



IP66, IK 08

[available colours](#)

LED white: IP68 connector included
LED RGBW: 2 m cable length

.06 grey
other colours available on request with
no price increase
.01 black; .02 white; .07 corten;
.08 anthracite; .09 bronze

platek.eu/TARGET

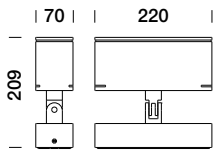

TARGET Large

16 LED white - 220-240V 0/50/60Hz ⊕

LED Data= 3000K (4000 lm) - 4000K (4160 lm)

88 20 611	●	34W	3000K (3075 lm)	9°
88 20 613	●	34W	3000K (2945 lm)	24°
88 20 618	○	34W	3000K (2760 lm)	48°
88 20 617	●	34W	3000K (2775 lm)	Elliptical
88 20 661	○	34W	4000K (3195 lm)	9°
88 20 663	○	34W	4000K (3065 lm)	24°
88 20 668	○	34W	4000K (2870 lm)	48°
88 20 667	○	34W	4000K (2885 lm)	Elliptical

TARGET Large

16 LED RGBW - 700mA - ⬡

(power supply to be ordered separately)

88 20 601	○	32W	RGBW	9°
88 20 603	○	32W	RGBW	24°
88 20 608	○	32W	RGBW	48°
88 20 607	○	32W	RGBW	Elliptical

ACCESSORIES

90 05 152	●	Spike
89 05 072	●	Visor
89 05 112	●	Deflector
RGBW		Control systems for dynamic light on page 102

NANO full inox floodlight



IP68 Full Dry (2m), IK 08

0,5 m cable length

platek.eu/NANOINOX

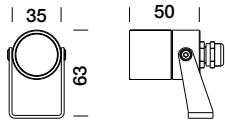

LED white - 700mA

(power supply to be ordered separately)

LED Data= 3000K (250 lm) - 4000K (260 lm)

84 32 011	●	2W	3000K (175 lm)	14°
84 32 013	●	2W	3000K (160 lm)	21°
84 32 018	●	2W	3000K (150 lm)	38°
84 32 017	○	2W	3000K (160 lm)	Elliptical
84 32 061	○	2W	4000K (180 lm)	14°
84 32 063	○	2W	4000K (170 lm)	21°
84 32 068	○	2W	4000K (155 lm)	38°
84 32 067	○	2W	4000K (165 lm)	Elliptical

ACCESSORIES

90 05 100	●	Stainless steel spike for floodlight
90 05 101	●	H. 285 mm stainless steel spike for floodlight
90 05 105	●	Anchor belt
89 35 210	●	Visor
89 35 211	●	Tube shield
90 05 250	●	H. 300 mm rod with aluminium spike
90 05 252	●	H. 600 mm rod with aluminium spike
90 05 255	●	H. 1100 mm rod with aluminium spike
90 05 260	●	H. 1700 mm rod with aluminium spike
89 17 006	●	IP68 connector for 2x0,75 mm ² cable
89 17 013	●	IP68 Micro Paguro connector for 2x1,5 mm ² cable
89 56 090	●	IP67 Power supply (700mA - 14W)
89 56 117	●	IP67 Power supply (700mA - 30W)

NANO floodlight



IP66, IK 08

5 m cable length

platek.eu/NANOFLOOD

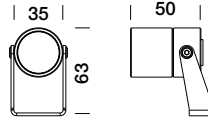

LED white - 12V DC

(power supply to be ordered separately)

LED Data= 3000K (250 lm) - 4000K (260 lm)

94 05 011	●	2,7W	3000K (175 lm)	14°
94 05 013	●	2,7W	3000K (160 lm)	21°
94 05 018	●	2,7W	3000K (150 lm)	38°
94 05 017	○	2,7W	3000K (160 lm)	Elliptical
94 05 061	○	2,7W	4000K (180 lm)	14°
94 05 063	○	2,7W	4000K (170 lm)	21°
94 05 068	○	2,7W	4000K (155 lm)	38°
94 05 067	○	2,7W	4000K (165 lm)	Elliptical

ACCESSORIES

90 05 100	●	Stainless steel spike for floodlight
90 05 101	●	H. 285 mm stainless steel spike for floodlight
90 05 105	●	Anchor belt
89 35 210	●	Visor
89 35 211	●	Tube shield
90 05 250	●	H. 300 mm rod with aluminium spike
90 05 252	●	H. 600 mm rod with aluminium spike
90 05 255	●	H. 1100 mm rod with aluminium spike
90 05 260	●	H. 1700 mm rod with aluminium spike
89 17 006	●	IP68 connector for 2x0,75 mm ² cable
89 17 012	●	IP68 connector for 4x1,5 mm ² cable
89 56 109	●	IP20 Power supply (12V DC - 18W) max. 8 products
89 56 091	●	IP67 Power supply (12V DC - 14W) max. 4 products
89 56 103	●	IP67 Power supply (12V DC - 60W) max. 19 products

available colours

.01 black; .08 anthracite; .09 bronze

other colours available on request with no price increase

.02 white; .06 grey; .07 corten;

NANO XL floodlight



IP66, IK 08

5 m cable length

platek.eu/NANOXL

available colours

.01 black; .02 white; .06 grey;
.07 corten; .08 anthracite; .09 bronze

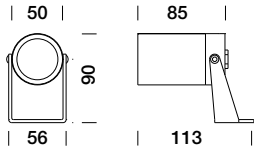

COB LED white - 220-240V 50/60Hz ⊕

TRIAC dimmable

LED Data= 3000K (704 lm) - 4000K (740 lm)

94 05 111	●	9W	3000K (200 lm)	20°
94 05 118	●	9W	3000K (240 lm)	30°
94 05 161	○	9W	4000K (210 lm)	20°
94 05 168	○	9W	4000K (250 lm)	30°

ACCESSORIES

90 05 605	●	Spike
90 05 105	●	Anchor belt
89 35 220	●	Shield visor
89 35 221	●	Tube shield
90 05 250	●	H. 300 mm rod with aluminium spike
90 05 252	●	H. 600 mm rod with aluminium spike
90 05 255	●	H. 1100 mm rod with aluminium spike
90 05 260	●	H. 1700 mm rod with aluminium spike
89 17 014	●	IP68 connector for 3x1,5 mm ² cable
89 17 004	●	IP68 IN/OUT connector for 3x4 mm ² cable

NANO XXL floodlight



IP66, IK 08

5 m cable length

platek.eu/NANOXXL

available colours

.01 black; .02 white; .06 grey;
.07 corten; .08 anthracite; .09 bronze

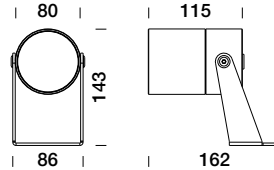

COB LED white - 220-240V 50/60Hz ⊕

TRIAC dimmable

LED Data= 3000K (1445 lm) - 4000K (1503 lm)

94 05 213	●	16W	3000K (970 lm)	32°
94 05 218	●	16W	3000K (1000 lm)	50°
94 05 263	○	16W	4000K (1010 lm)	32°
94 05 268	○	16W	4000K (1040 lm)	50°

ACCESSORIES

90 05 605	●	Spike
90 05 105	●	Anchor belt
89 51 040	●	Connection to the pole 60 mm Ø
89 51 045	●	Connection to the pole 102 mm Ø
89 51 050	●	Connection to the pole 114 mm Ø
89 35 230	●	Visor
89 35 231	●	Tube shield
89 17 014	●	IP68 connector for 3x1,5 mm ² cable
89 17 004	●	IP68 IN/OUT connector for 3x4 mm ² cable
90 05 250	●	H. 300 mm rod with aluminium spike
90 05 252	●	H. 600 mm rod with aluminium spike
90 05 255	●	H. 1100 mm rod with aluminium spike
90 05 260	●	H. 1700 mm rod with aluminium spike

MINI ONE floodlight

ONE 2.0 floodlight



IP66, IK 08

platek.eu/MINIONE

available colours

.06 grey; .08 anthracite

other colours available on request with no price increase

.01 black; .02 white;

.07 corten; .09 bronze

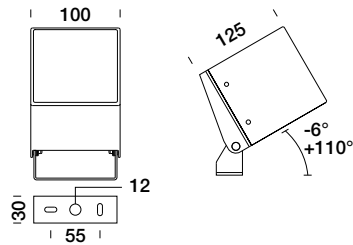

1 LED white - 220-240V 0/50/60Hz ⊕

Sandblasted glass

LED Data= 3000K (600 lm) - 4000K (624 lm)

10 13 615	○	7,8W	3000K (430 lm)	Diffuse
10 13 665	○	7,8W	4000K (450 lm)	Diffuse

3 LED white - 220-240V 0/50/60Hz ⊕

Transparent glass

LED Data= 3000K (565 lm) - 4000K (588 lm)

10 12 111	●	5,9W	3000K (465 lm)	12°
10 12 113	○	5,9W	3000K (435 lm)	33°
10 12 118	○	5,9W	3000K (440 lm)	44°
10 12 161	○	5,9W	4000K (485 lm)	12°
10 12 163	○	5,9W	4000K (450 lm)	33°
10 12 168	○	5,9W	4000K (460 lm)	44°

4 LED RGBW - 500mA - ◆

(power supply to be ordered separately)

83 12 101	○	5,8W	RGBW	12°
83 12 103	○	5,8W	RGBW	33°
83 12 108	○	5,8W	RGBW	44°

ACCESSORIES

90 05 605	●	Spike
-----------	---	-------

RGBW Control systems for dynamic light on page 102

● Product available in stock

○ Product available on request

IP65, IK 07

platek.eu/ONE

available colours

.06 grey; .08 anthracite

other colours available on request with no price increase

.01 black; .02 white;

.07 corten; .09 bronze

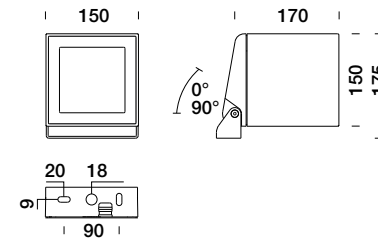

COB LED white - 220-240V 50/60Hz ⊕

Integral DALI driver

LED Data= 3000K (3690 lm) - 4000K (3835 lm)

15 18 613	●	27W	3000K (2550 lm)	Diffuse	Sandblasted
15 18 663	○	27W	4000K (2650 lm)	Diffuse	Sandblasted

LED white - 220-240V 0/50/60Hz ⊕

Integral DALI driver

9 LED Data= 3000K (2250 lm) - 4000K (2340 lm)

15 17 311	●	20,5W	3000K (2000 lm)	9°
15 17 313	●	20,5W	3000K (1950 lm)	25°
15 17 318	○	20,5W	3000K (1780 lm)	48°
15 17 317	○	20,5W	3000K (1830 lm)	Elliptical
15 17 361	○	20,5W	4000K (2080 lm)	9°
15 17 363	○	20,5W	4000K (2030 lm)	25°
15 17 368	○	20,5W	4000K (1850 lm)	48°
15 17 367	○	20,5W	4000K (1905 lm)	Elliptical

16 LED RGBW - 500mA - ◆

(power supply to be ordered separately)

83 49 401	○	23W	RGBW	9°
83 49 403	○	23W	RGBW	28°
83 49 408	○	23W	RGBW	45°
83 49 407	○	23W	RGBW	Elliptical

ACCESSORIES

90 05 600	●	Spike
-----------	---	-------

RGBW Control systems for dynamic light on page 102

● Product available on request until the end of stocks

MINI SPECIAL floodlight



IP65, IK 05

platek.eu/MINISPECIAL

available colours

.06 grey; .08 anthracite

other colours available on request with no price increase

.01 black; .02 white;

.07 corten; .09 bronze

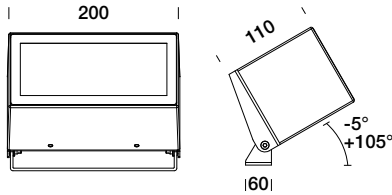

4 LED white - 220-240V 0/50/60Hz ⊕

Transparent glass

LED Data= 3000K (1875 lm) - 4000K (1950 lm)

10 22 819	<input checked="" type="radio"/>	17,5W	3000K (1600 lm)	Asymmetric
10 22 869	<input type="radio"/>	17,5W	4000K (1665 lm)	Asymmetric

1 LED white - 220-240V 0/50/60Hz ⊕

Sandblasted glass

LED Data= 3000K (1000 lm) - 4000K (1040 lm)

10 22 610	<input type="radio"/>	10W	3000K (550 lm)	Diffuse
10 22 660	<input type="radio"/>	10W	4000K (570 lm)	Diffuse

ACCESSORIES

90 05 605	<input checked="" type="radio"/>	Spike
-----------	----------------------------------	-------

Product available in stock

Product available on request

Product available on request until the end of stocks

MICRO SPRING floodlight design by Lundbergdesign



IP65, IK 06

LED white: 0,5 m cable length
LED RGBW: 1,5 m cable length

platek.eu/MICROSPRING

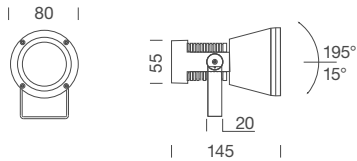

LED white - 220-240V 0/50/60Hz ⊕
3 LED Data= 3000K (540 lm) - 4000K (562 lm)

84 24 111	○	5,9W	3000K (465 lm)	12°
84 24 113	○	5,9W	3000K (435 lm)	33°
84 24 118	○	5,9W	3000K (440 lm)	44°
84 24 161	○	5,9W	4000K (485 lm)	12°
84 24 163	○	5,9W	4000K (450 lm)	33°
84 24 168	○	5,9W	4000K (460 lm)	44°

4 LED RGBW - 500mA - ⬠
(power supply to be ordered separately)

83 24 101	○	5,8W	RGBW	12°
83 24 103	○	5,8W	RGBW	33°
83 24 108	○	5,8W	RGBW	44°

ACCESSORIES

89 18 780	●	Elliptical filter
89 18 785	●	Sandblasted filter
89 18 786	●	Honeycomb grid
89 18 787	●	Antiglare deflector
89 05 010	●	Visor (in colour .01)
89 05 080	●	Tube shield (in colour .01)
90 05 605	●	Spike
89 17 014	●	IP68 connector for 3x1,5 mm ² cable
89 17 004	●	IP68 IN/OUT connector for 3x4 mm ² cable
RGBW		Control systems for dynamic light on page 102

MINI SPRING floodlight design by Lundbergdesign



IP65, IK 06

LED white: 1 m cable length
LED RGBW: 1 m cable length

platek.eu/MINISPRING

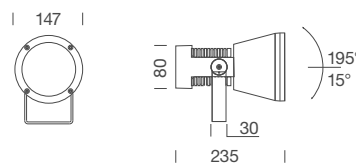

COB LED white - 220-240V 0/50/60Hz ⊕
LED Data= 3000K (2340 lm) - 4000K (2433 lm)

88 14 511	○	19W	3000K (1330 lm)	20°
88 14 513	○	19W	3000K (1190 lm)	36°
88 14 518	○	19W	3000K (1035 lm)	54°
88 14 561	○	19W	4000K (1385 lm)	20°
88 14 563	○	19W	4000K (1240 lm)	36°
88 14 568	○	19W	4000K (1075 lm)	54°

LED white - 220-240V 0/50/60Hz ⊕
9 LED Data= 3000K (2250 lm) - 4000K (2340 lm)

84 23 311	○	22W	3000K (1705 lm)	9°
84 23 313	○	22W	3000K (1610 lm)	28°
84 23 318	○	22W	3000K (1530 lm)	45°
84 23 361	○	22W	4000K (1775 lm)	9°
84 23 363	○	22W	4000K (1675 lm)	28°
84 23 368	○	22W	4000K (1595 lm)	45°

16 LED RGBW - 350mA - ⬠
(power supply to be ordered separately)

83 23 401	○	16W	RGBW	9°
83 23 403	○	16W	RGBW	28°
83 23 408	○	16W	RGBW	44°

ACCESSORIES

89 18 670	●	Elliptical filter
89 18 675	●	Sandblasted filter
90 05 600	●	Spike
89 05 015	●	Visor (in colour .01)
89 05 085	●	Tube shield (in colour .01)
89 51 040	●	Connection to the pole 60 mm Ø
89 51 045	●	Connection to the pole 102 mm Ø
89 51 050	●	Connection to the pole 114 mm Ø
89 17 014	●	IP68 connector for 3x1,5 mm ² cable
89 17 004	●	IP68 IN/OUT connector for 3x4 mm ² cable
RGBW		Control systems for dynamic light on page 102

SPRING floodlight design by Lundbergdesign



IP65, IK 06

LED white: 3 m cable length
LED RGBW: 3 m cable length

other colours available on request with
no price increase

.01 black; .02 white; .06 grey;
.07 corten; .08 anthracite; .09 bronze

platek.eu/ONE

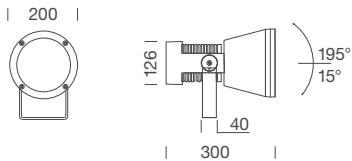

COB LED white - 220-240V 50/60Hz
LED Data= 3000K (5300 lm) - 4000K (5512 lm)

88 15 811	○	45W	3000K (3910 lm)	18°
88 15 813	○	45W	3000K (4090 lm)	38°
88 15 861	○	45W	4000K (4065 lm)	18°
88 15 863	○	45W	4000K (4090 lm)	38°

LED white - 220-240V 0/50/60Hz
18 LED Data= 3000K (4680 lm) - 4000K (4867 lm)

84 22 511	○	44W	3000K (3675 lm)	9°
84 22 513	○	44W	3000K (3645 lm)	28°
84 22 518	○	44W	3000K (3080 lm)	45°
84 22 561	○	44W	4000K (3820 lm)	9°
84 22 563	○	44W	4000K (3790 lm)	28°
84 22 568	○	44W	4000K (3205 lm)	45°

24 LED RGBW - 500mA -
(power supply to be ordered separately)

83 22 501	○	35W	RGBW	9°
83 22 503	○	35W	RGBW	28°
83 22 508	○	35W	RGBW	45°

ACCESSORIES

89 18 660	●	Elliptical filter
89 18 665	●	Sandblasted filter
90 05 600	●	Spike
89 05 020	●	Visor (in colour .01)
89 05 090	●	Tube shield (in colour .01)
89 51 040	●	Connection to the pole 60 mm Ø
89 51 045	●	Connection to the pole 102 mm Ø
89 51 050	●	Connection to the pole 114 mm Ø
89 17 014	●	IP68 connector for 3x1,5 mm ² cable
89 17 004	●	IP68 IN/OUT connector for 3x4 mm ² cable
RGBW		Control systems for dynamic light on page 102

MINI floodlight



IP68 (2m), IK 06

LED white: 1 m cable length
LED RGBW: 1 m cable length

platek.eu/MINI

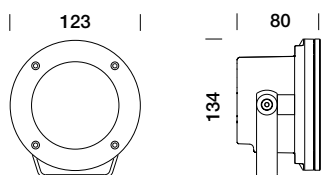

6 LED white - 220-240V 0/50/60Hz

TRIAC dimmable

LED Data= 3000K (1128 lm) - 4000K (1173 lm)

84 21 611	○	11W	3000K (955 lm)	9°
84 21 613	○	11W	3000K (855 lm)	28°
84 21 618	○	11W	3000K (775 lm)	44°
84 21 661	○	11W	4000K (995 lm)	9°
84 21 663	○	11W	4000K (890 lm)	28°
84 21 668	○	11W	4000K (805 lm)	44°

8 LED RGBW - 500mA -

(power supply to be ordered separately)

83 21 201	○	11,5W	RGBW	9°
83 21 203	○	11,5W	RGBW	28°
83 21 208	○	11,5W	RGBW	44°

ACCESSORIES

90 05 600	●	Spike
89 18 750	●	Elliptical filter
89 18 755	●	Sandblasted filter
89 05 025	●	Visor (in colour .01)
89 05 026	●	Tube shield (in colour .01)
89 51 040	●	Connection to the pole Ø 60 mm
89 51 045	●	Connection to the pole Ø 102 mm
89 51 050	●	Connection to the pole Ø 114 mm
89 17 014	●	IP68 connector for 3x1,5 mm ² cable
89 17 004	●	IP68 IN/OUT connector for 3x4 mm ² cable
RGBW		Control systems for dynamic light on page 102

STEEL 200 floodlight



IP68 Full Dry (2m), IK 08

LED white: 5 m cable length
LED RGBW: 5 m cable length

platek.eu/STEEL200

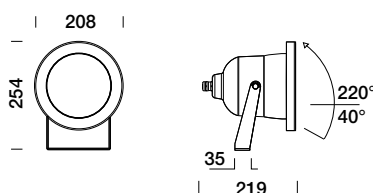

9 LED white - 220-240V 0/50/60Hz

LED Data= 3000K (1620 lm) - 4000K (1685 lm)

84 25 311	○	15,5W	3000K (1475 lm)	9°
84 25 313	○	15,5W	3000K (1325 lm)	28°
84 25 318	○	15,5W	3000K (1140 lm)	45°
84 25 361	○	15,5W	4000K (1535 lm)	9°
84 25 363	○	15,5W	4000K (1375 lm)	28°
84 25 368	○	15,5W	4000K (1185 lm)	45°

16 LED RGBW - 350mA -

(power supply to be ordered separately)

83 74 401	○	16W	RGBW	9°
83 74 403	○	16W	RGBW	28°
83 74 408	○	16W	RGBW	45°

ACCESSORIES

89 18 650	●	Elliptical filter
89 18 655	●	Sandblasted filter
89 17 014	●	IP68 connector for 3x1,5 mm ² cable
89 17 004	●	IP68 IN/OUT connector for 3x4 mm ² cable
RGBW		Control systems for dynamic light on page 102

MINI CORNICHE INOX 100



IP68 Full Dry (2m), IK 08

LED white: 5 m cable length
LED RGBW: 2 m cable length

platek.eu/MINICORNICHEINOX

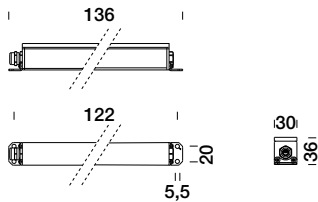

3 LED white - 24V DC - (power supply to be ordered separately)
LED Data= 3000K (375 lm) - 4000K (390 lm)

84 19 111	○	3,5W	3000K (250 lm)	13°
84 19 113	○	3,5W	3000K (255 lm)	26°
84 19 118	○	3,5W	3000K (230 lm)	40°
84 19 117	○	3,5W	3000K (215 lm)	Elliptical
84 19 161	○	3,5W	4000K (260 lm)	13°
84 19 163	○	3,5W	4000K (265 lm)	26°
84 19 168	○	3,5W	4000K (240 lm)	40°
84 19 167	○	3,5W	4000K (220 lm)	Elliptical

4 LED RGBW - 500mA - (power supply to be ordered separately)

83 77 101	○	6W	RGBW	13°
83 77 103	○	6W	RGBW	26°
83 77 108	○	6W	RGBW	40°
83 77 107	○	6W	RGBW	Elliptical

ACCESSORIES

89 17 006	●	IP68 connector for 2x0,75 mm ² cable
89 17 012	●	IP68 connector for 4x1,5 mm ² cable
89 56 104	●	IP20 Power supply (24V DC - 30W)
89 56 307	●	IP20 Power supply (24V DC - 75W)
89 56 172	●	IP67 Power supply (24V DC - 30W)
89 56 127	●	IP67 Power supply (24V DC - 75W)
89 56 074	●	IP67 Power supply (24V DC - 150W)
ON/OFF		Further power supplies are available on page 105
RGBW		Control systems for dynamic light on page 102

MINI CORNICHE INOX 300



IP68 Full Dry (2m), IK 08

LED white: 5 m cable length
LED RGBW: 2 m cable length

platek.eu/MINICORNICHEINOX

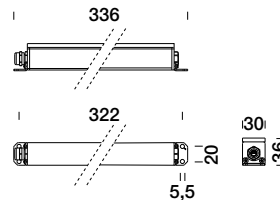

6 LED white - 24V DC - (power supply to be ordered separately)
LED Data= 3000K (750 lm) - 4000K (780 lm)

84 19 211	○	6,5W	3000K (490 lm)	13°
84 19 213	○	6,5W	3000K (515 lm)	26°
84 19 218	○	6,5W	3000K (465 lm)	40°
84 19 217	○	6,5W	3000K (430 lm)	Elliptical
84 19 261	○	6,5W	4000K (520 lm)	13°
84 19 263	○	6,5W	4000K (535 lm)	26°
84 19 268	○	6,5W	4000K (480 lm)	40°
84 19 267	○	6,5W	4000K (445 lm)	Elliptical

8 LED RGBW - 500mA - (power supply to be ordered separately)

83 77 201	○	11,5W	RGBW	13°
83 77 203	○	11,5W	RGBW	26°
83 77 208	○	11,5W	RGBW	40°
83 77 207	○	11,5W	RGBW	Elliptical

ACCESSORIES

89 17 006	●	IP68 connector for 2x0,75 mm ² cable
89 17 012	●	IP68 connector for 4x1,5 mm ² cable
89 56 104	●	IP20 Power supply (24V DC - 30W)
89 56 307	●	IP20 Power supply (24V DC - 75W)
89 56 172	●	IP67 Power supply (24V DC - 30W)
89 56 127	●	IP67 Power supply (24V DC - 75W)
89 56 074	●	IP67 Power supply (24V DC - 150W)
ON/OFF		Further power supplies are available on page 105
RGBW		Control systems for dynamic light on page 102

NETTUNO floodlight



IP68 Full Dry (2m), IK 06

LED white: 5 m cable length
LED RGBW: 5 m cable length

platek.eu/NETTUNO

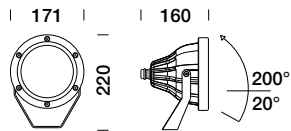

9 LED white - 24V DC - (power supply to be ordered separately)
LED Data= 3000K (1644 lm) - 4000K (1710 lm)

84 72 311	○	15W	3000K (1475 lm)	9°
84 72 318	○	15W	3000K (1140 lm)	45°
84 72 317	○	15W	3000K (1170 lm)	Elliptical
84 72 361	○	15W	4000K (1535 lm)	9°
84 72 368	○	15W	4000K (1185 lm)	45°
84 72 367	○	15W	4000K (1220 lm)	Elliptical

16 LED RGBW - 350mA - (power supply to be ordered separately)

83 72 401	○	16W	RGBW	9°
83 72 408	○	16W	RGBW	45°
83 72 407	○	16W	RGBW	Elliptical

ACCESSORIES

89 17 004	●	IP68 IN/OUT connector for 3x4 mm ² cable
89 56 104	●	IP20 Power supply (24V DC - 30W)
89 56 307	●	IP20 Power supply (24V DC - 75W)
89 56 172	●	IP67 Power supply (24V DC - 30W)
89 56 127	●	IP67 Power supply (24V DC - 75W)
89 56 074	●	IP67 Power supply (24V DC - 150W)
ON/OFF		Further power supplies are available on page 105
RGBW		Control systems for dynamic light on page 102

NETTUNO recessed



IP68 Full Dry (2m), IK 06

LED white: 5 m cable length
LED RGBW: 5 m cable length

platek.eu/NETTUNO

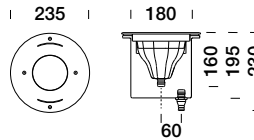

9 LED white - 24V DC - (power supply to be ordered separately)
LED Data= 3000K (1644 lm) - 4000K (1710 lm)

84 73 311	○	15W	3000K (1475 lm)	9°
84 73 318	○	15W	3000K (1140 lm)	45°
84 73 317	○	15W	3000K (1170 lm)	Elliptical
84 73 361	○	15W	4000K (1535 lm)	9°
84 73 368	○	15W	4000K (1185 lm)	45°
84 73 367	○	15W	4000K (1220 lm)	Elliptical

16 LED RGBW - 350mA - (power supply to be ordered separately)

83 73 401	○	16W	RGBW	9°
83 73 403	○	16W	RGBW	28°
83 73 408	○	16W	RGBW	45°

ACCESSORIES

89 17 004	●	IP68 IN/OUT connector for 3x4 mm ² cable
89 28 065	●	IP68 Stainless steel recessed box for PVC coatings
89 56 104	●	IP20 Power supply (24V DC - 30W)
89 56 307	●	IP20 Power supply (24V DC - 75W)
89 56 172	●	IP67 Power supply (24V DC - 30W)
89 56 127	●	IP67 Power supply (24V DC - 75W)
89 56 074	●	IP67 Power supply (24V DC - 150W)
ON/OFF		Further power supplies are available on page 105
RGBW		Control systems for dynamic light on page 102

ATLANTIQUE Bronze floodlight



IP68 Full Dry (2m), IK 10

LED white: 3 m cable length
LED RGBW: 5 m cable length

platek.eu/ATLANTIQUE

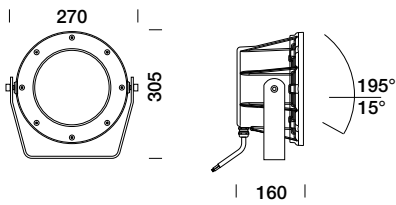

18 LED white - 24V DC - 
(power supply to be ordered separately)
LED Data= 3000K (3385 lm) - 4000K (3520 lm)

84 78 511	○	32W	3000K (2780 lm)	9°
84 78 518	○	32W	3000K (2330 lm)	45°
84 78 561	○	32W	4000K (2890 lm)	9°
84 78 568	○	32W	4000K (2425 lm)	45°

24 LED RGBW - 500mA - 
(power supply to be ordered separately)

83 78 501	○	35W	RGBW	9°
83 78 508	○	35W	RGBW	45°

ACCESSORIES

89 18 205	●	Sandblasted filter
89 56 104	●	IP20 Power supply (24V DC - 30W)
89 56 307	●	IP20 Power supply (24V DC - 75W)
89 56 172	●	IP67 Power supply (24V DC - 30W)
89 56 127	●	IP67 Power supply (24V DC - 75W)
89 56 074	●	IP67 Power supply (24V DC - 150W)
89 17 004	●	IP68 IN/OUT connector for 3x4 mm ² cable
89 17 014	●	IP68 connector for 3x1,5 mm ² cable
ON/OFF		Further power supplies are available on page 105
RGBW		Control systems for dynamic light on page 102

MICRO STEEL full inox floodlight



IP68 Full Dry (2m), IK 10

LED white: 5 m cable length
LED RGBW: 5 m cable length

platek.eu/MICROFULLINOX

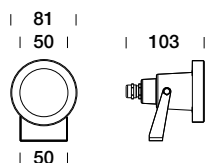

3 LED white - 24V DC - (power supply to be ordered separately)
LED Data= 3000K (540 lm) - 4000K (562 lm)

84 75 111	○	5,9W	3000K (465 lm)	12°
84 75 113	○	5,9W	3000K (435 lm)	33°
84 75 118	○	5,9W	3000K (440 lm)	44°
84 75 161	○	5,9W	4000K (485 lm)	12°
84 75 163	○	5,9W	4000K (450 lm)	33°
84 75 168	○	5,9W	4000K (460 lm)	44°

4 LED RGBW - 500mA - (power supply to be ordered separately)

83 75 101	○	5,8W	RGBW	12°
83 75 103	○	5,8W	RGBW	33°
83 75 108	○	5,8W	RGBW	44°

ACCESSORIES

89 17 006	●	IP68 connector for 2x0,75 mm ² cable
89 17 012	●	IP68 connector for 4x1,5 mm ² cable
89 17 004	●	IP68 IN/OUT connector for 3x4 mm ² cable
89 56 104	●	IP20 Power supply (24V DC - 30W)
89 56 307	●	IP20 Power supply (24V DC - 75W)
89 56 172	●	IP67 Power supply (24V DC - 30W)
89 56 127	●	IP67 Power supply (24V DC - 75W)
89 56 074	●	IP67 Power supply (24V DC - 150W)
ON/OFF		Further power supplies are available on page 105
RGBW		Control systems for dynamic light on page 102

MICRO STEEL full inox underwater

Diffuse



IP68 Full Dry (2m), IK 10

LED white: 5 m cable length
LED RGBW: 5 m cable length

platek.eu/MICROFULLINOX

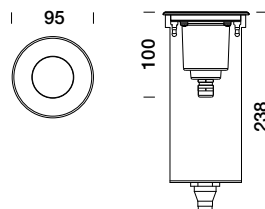

3 LED white - 24V DC - (power supply to be ordered separately)
LED Data= 3000K (540 lm) - 4000K (562 lm)

84 76 111	○	5,9W	3000K (465 lm)	12°
84 76 113	○	5,9W	3000K (435 lm)	33°
84 76 118	○	5,9W	3000K (440 lm)	44°
84 76 161	○	5,9W	4000K (485 lm)	12°
84 76 163	○	5,9W	4000K (450 lm)	33°
84 76 168	○	5,9W	4000K (460 lm)	44°

4 LED RGBW - 500mA - (power supply to be ordered separately)

83 76 101	○	5,8W	RGBW	12°
83 76 103	○	5,8W	RGBW	33°
83 76 108	○	5,8W	RGBW	44°

ACCESSORIES

89 28 045	●	Stainless steel IP68 recessed box for PVC coatings
89 17 006	●	IP68 connector for 2x0,75 mm ² cable
89 17 012	●	IP68 connector for 4x1,5 mm ² cable
89 17 004	●	IP68 IN/OUT connector for 3x4 mm ² cable
89 56 104	●	IP20 Power supply (24V DC - 30W)
89 56 307	●	IP20 Power supply (24V DC - 75W)
89 56 172	●	IP67 Power supply (24V DC - 30W)
89 56 127	●	IP67 Power supply (24V DC - 75W)
89 56 074	●	IP67 Power supply (24V DC - 150W)
ON/OFF		Further power supplies are available on page 105
RGBW		Control systems for dynamic light on page 102

STEEL 200 full inox floodlight



IP68 Full Dry (2m), IK 08

LED white: 5 m cable length
LED RGBW: 5 m cable length

platek.eu/STEEL200

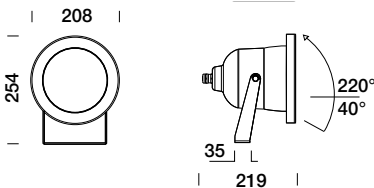

9 LED white - 24V DC - (power supply to be ordered separately)
LED Data= 3000K (1620 lm) - 4000K (1685 lm)

84 74 311	○	15W	3000K (1140 lm)	9°
84 74 318	○	15W	3000K (1195 lm)	45°
84 74 361	○	15W	4000K (1190 lm)	9°
84 74 368	○	15W	4000K (1240 lm)	45°

16 LED RGBW - 350mA - (power supply to be ordered separately)

83 74 401	○	16W	RGBW	9°
83 74 403	○	16W	RGBW	28°
83 74 408	○	16W	RGBW	45°

ACCESSORIES

89 18 650	●	Elliptical filter
89 18 655	●	Sandblasted filter
89 17 004	●	IP68 IN/OUT connector for 3x4 mm ² cable
89 56 104	●	IP20 Power supply (24V DC - 30W)
89 56 307	●	IP20 Power supply (24V DC - 75W)
89 56 172	●	IP67 Power supply (24V DC - 30W)
89 56 127	●	IP67 Power supply (24V DC - 75W)
89 56 074	●	IP67 Power supply (24V DC - 150W)
ON/OFF		Further power supplies are available on page 105
RGBW		Control systems for dynamic light on page 102

MINI CORNICHE 100 ceiling recessed



Diffuse



Asymmetric



IP65, IK 05

LED white: 2 m cable length
LED RGBW: 2 m cable length

platek.eu/MINI-CORNICHE

other colours available on request with no price increase
.01 black; .02 white; .06 grey
.07 corten; .08 anthracite; .09 bronze

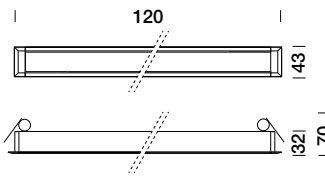

Fixing hole 36 x 110 mm



3 LED white - 24V DC - (power supply to be ordered separately)
LED Data= 3000K (375 lm) - 4000K (390 lm)

84 92 111	○	3,5W	3000K (250 lm)	13°
84 92 113	○	3,5W	3000K (255 lm)	26°
84 92 118	○	3,5W	3000K (230 lm)	40°
84 92 117	○	3,5W	3000K (215 lm)	Elliptical
84 92 161	○	3,5W	4000K (260 lm)	13°
84 92 163	○	3,5W	4000K (265 lm)	26°
84 92 168	○	3,5W	4000K (245 lm)	40°
84 92 167	○	3,5W	4000K (225 lm)	Elliptical

LED white - 24V DC - (power supply to be ordered separately)
LED Data= 3000K (120 lm) - 4000K (125 lm)

84 92 116	○	1,5W	3000K (90 lm)	Diffuse	Sandblasted
84 92 119	○	1,5W	3000K (60 lm)	Asymmetric	
84 92 166	○	1,5W	4000K (90 lm)	Diffuse	Sandblasted
84 92 169	○	1,5W	4000K (60 lm)	Asymmetric	

4 LED RGBW - 500mA - (power supply to be ordered separately)

83 92 101	○	6W	RGBW	13°
83 92 103	○	6W	RGBW	26°
83 92 107	○	6W	RGBW	Elliptical
83 92 108	○	6W	RGBW	40°

ACCESSORIES

89 17 006	●	IP68 connector for 2x0,75 mm ² cable
89 17 012	●	IP68 connector for 4x1,5 mm ² cable
89 56 104	●	IP20 Power supply (24V DC - 30W)
89 56 307	●	IP20 Power supply (24V DC - 75W)
89 56 172	●	IP67 Power supply (24V DC - 30W)
89 56 127	●	IP67 Power supply (24V DC - 75W)
89 56 074	●	IP67 Power supply (24V DC - 150W)
ON/OFF		Further power supplies are available on page 105
RGBW		Control systems for dynamic light on page 102

MINI CORNICHE 300

ceiling recessed

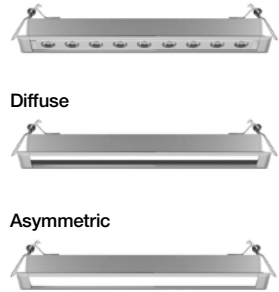

IP65, IK 05
LED white: 2 m cable length
LED RGBW: 2 m cable length

other colours available on request with no price increase
.01 black;.02 white;.06 grey
.07 corten;.08 anthracite;.09 bronze

platek.eu/MINI-CORNICHE

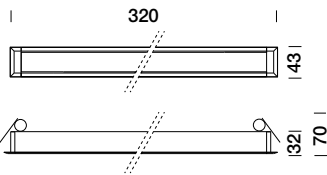

Fixing hole 36 x 310 mm



9 LED white - 24V DC -
(power supply to be ordered separately)
LED Data= 3000K (1125 lm) - 4000K (1170 lm)

84 92 311	○	9,5W	3000K (750 lm)	13°
84 92 313	○	9,5W	3000K (770 lm)	26°
84 92 318	○	9,5W	3000K (700 lm)	40°
84 92 317	○	9,5W	3000K (650 lm)	Elliptical
84 92 361	○	9,5W	4000K (780 lm)	13°
84 92 363	○	9,5W	4000K (800 lm)	26°
84 92 368	○	9,5W	4000K (730 lm)	40°
84 92 367	○	9,5W	4000K (675 lm)	Elliptical

LED white - 24V DC -
(power supply to be ordered separately)
LED Data= 3000K (560 lm) - 4000K (582 lm)

84 92 316	○	5,5W	3000K (415 lm)	Diffuse Sandblasted
84 92 319	○	6W	3000K (170 lm)	Asymmetric
84 92 366	○	5,5W	4000K (430 lm)	Diffuse Sandblasted
84 92 369	○	6W	4000K (175 lm)	Asymmetric

8 LED RGBW - 500mA -
(power supply to be ordered separately)

83 92 301	○	11,5W	RGBW	13°
83 92 303	○	11,5W	RGBW	26°
83 92 307	○	11,5W	RGBW	Elliptical
83 92 308	○	11,5W	RGBW	40°

ACCESSORIES

89 17 006	●	IP68 connector for 2x0,75 mm ² cable
89 17 012	●	IP68 connector for 4x1,5 mm ² cable
89 56 104	●	IP20 Power supply (24V DC - 30W)
89 56 307	●	IP20 Power supply (24V DC - 75W)
89 56 172	●	IP67 Power supply (24V DC - 30W)
89 56 127	●	IP67 Power supply (24V DC - 75W)
89 56 074	●	IP67 Power supply (24V DC - 150W)
ON/OFF		Further power supplies are available on page 105
RGBW		Control systems for dynamic light on page 102

MINI CORNICHE 600

ceiling recessed

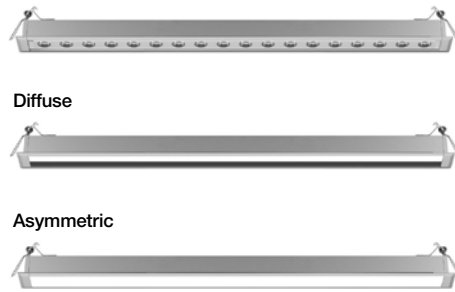

IP65, IK 05
LED white: 2 m cable length
LED RGBW: 2 m cable length

other colours available on request with no price increase
.01 black;.02 white;.06 grey
.07 corten;.08 anthracite;.09 bronze

platek.eu/MINI-CORNICHE

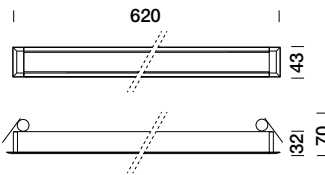

Fixing hole 36 x 610 mm



18 LED white - 24V DC -
(power supply to be ordered separately)
LED Data= 3000K (2250 lm) - 4000K (2340 lm)

84 92 511	○	18,5W	3000K (1500 lm)	13°
84 92 513	○	18,5W	3000K (1545 lm)	26°
84 92 518	○	18,5W	3000K (1400 lm)	40°
84 92 517	○	18,5W	3000K (1290 lm)	Elliptical
84 92 561	○	18,5W	4000K (1560 lm)	13°
84 92 563	○	18,5W	4000K (1605 lm)	26°
84 92 568	○	18,5W	4000K (1455 lm)	40°
84 92 567	○	18,5W	4000K (1345 lm)	Elliptical

LED white - 24V DC -
(power supply to be ordered separately)
LED Data= 3000K (1110 lm) - 4000K (1154 lm)

84 92 516	○	10,5W	3000K (820 lm)	Diffuse Sandblasted
84 92 519	○	11W	3000K (335 lm)	Asymmetric
84 92 566	○	10,5W	4000K (860 lm)	Diffuse Sandblasted
84 92 569	○	11W	4000K (350 lm)	Asymmetric

16 LED RGBW - 500mA -
(power supply to be ordered separately)

83 92 501	○	23W	RGBW	13°
83 92 503	○	23W	RGBW	26°
83 92 507	○	23W	RGBW	Elliptical
83 92 508	○	23W	RGBW	40°

ACCESSORIES

89 17 006	●	IP68 connector for 2x0,75 mm ² cable
89 17 012	●	IP68 connector for 4x1,5 mm ² cable
89 56 104	●	IP20 Power supply (24V DC - 30W)
89 56 307	●	IP20 Power supply (24V DC - 75W)
89 56 172	●	IP67 Power supply (24V DC - 30W)
89 56 127	●	IP67 Power supply (24V DC - 75W)
89 56 074	●	IP67 Power supply (24V DC - 150W)
ON/OFF		Further power supplies are available on page 105
RGBW		Control systems for dynamic light on page 102

MINI CORNICHE 900

ceiling recessed

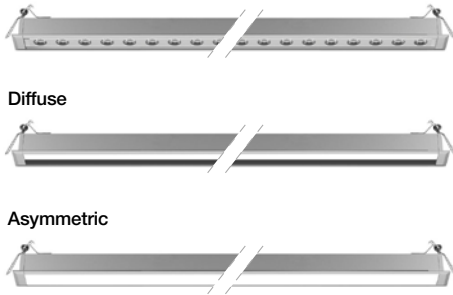

IP65, IK 05

LED white: 2 m cable length
LED RGBW: 2 m cable length

platek.eu/MINI-CORNICHE

other colours available on request with no price increase

.01 black; .02 white; .06 grey
.07 corten; .08 anthracite; .09 bronze

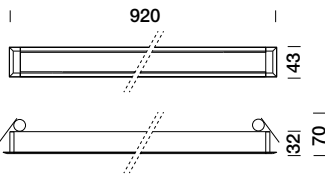

Fixing hole 36 x 910 mm



27 LED white - 24V DC -

(power supply to be ordered separately)
LED Data= 3000K (3375 lm) - 4000K (3510 lm)

84 92 711	○	29W	3000K (2255 lm)	13°
84 92 713	○	29W	3000K (2320 lm)	26°
84 92 718	○	29W	3000K (2100 lm)	40°
84 92 717	○	29W	3000K (1940 lm)	Elliptical
84 92 761	○	29W	4000K (2350 lm)	13°
84 92 763	○	29W	4000K (2415 lm)	26°
84 92 768	○	29W	4000K (2185 lm)	40°
84 92 767	○	29W	4000K (2020 lm)	Elliptical

LED white - 24V DC -

(power supply to be ordered separately)
LED Data= 3000K (560 lm) - 4000K (582 lm)

84 92 716	○	15,5W	3000K (1240 lm)	Diffuse Sandblasted
84 92 719	○	17W	3000K (505 lm)	Asymmetric
84 92 766	○	15,5W	4000K (1280 lm)	Diffuse Sandblasted
84 92 769	○	17W	4000K (525 lm)	Asymmetric

24 LED RGBW - 500mA -

(power supply to be ordered separately)

83 92 701	○	35W	RGBW	13°
83 92 703	○	35W	RGBW	26°
83 92 707	○	35W	RGBW	Elliptical
83 92 708	○	35W	RGBW	40°

ACCESSORIES

89 17 006	●	IP68 connector for 2x0,75 mm ² cable
89 17 012	●	IP68 connector for 4x1,5 mm ² cable
89 56 104	●	IP20 Power supply (24V DC - 30W)
89 56 307	●	IP20 Power supply (24V DC - 75W)
89 56 172	●	IP67 Power supply (24V DC - 30W)
89 56 127	●	IP67 Power supply (24V DC - 75W)
89 56 074	●	IP67 Power supply (24V DC - 150W)
ON/OFF		Further power supplies are available on page 105
RGBW		Control systems for dynamic light on page 102

● Product available in stock

○ Product available on request

MINI CORNICHE 1200

ceiling recessed

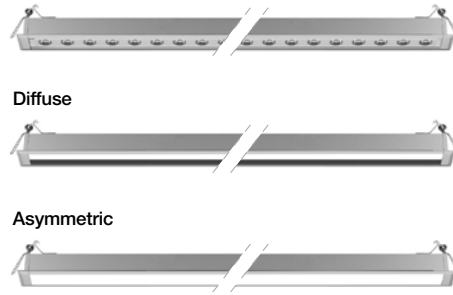

IP65, IK 05

LED white: 2 m cable length
LED RGBW: 2 m cable length

platek.eu/MINI-CORNICHE

other colours available on request with no price increase

.01 black; .02 white; .06 grey
.07 corten; .08 anthracite; .09 bronze

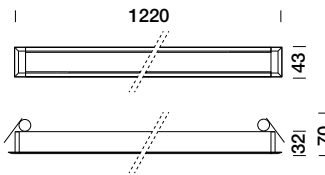

Fixing hole 36 x 1210 mm



36 LED white - 24V DC -

(power supply to be ordered separately)
LED Data= 3000K (4500 lm) - 4000K (4680 lm)

84 92 611	○	40W	3000K (3000 lm)	13°
84 92 613	○	40W	3000K (3090 lm)	26°
84 92 618	○	40W	3000K (2800 lm)	40°
84 92 617	○	40W	3000K (2590 lm)	Elliptical
84 92 661	○	40W	4000K (3125 lm)	13°
84 92 663	○	40W	4000K (3215 lm)	26°
84 92 668	○	40W	4000K (2900 lm)	40°
84 92 667	○	40W	4000K (2690 lm)	Elliptical

LED white - 24V DC -

(power supply to be ordered separately)
LED Data= 3000K (2250 lm) - 4000K (2340 lm)

84 92 616	○	21W	3000K (1650 lm)	Diffuse Sandblasted
84 92 619	○	22W	3000K (680 lm)	Asymmetric
84 92 666	○	21W	4000K (1720 lm)	Diffuse Sandblasted
84 92 669	○	22W	4000K (700 lm)	Asymmetric

32 LED RGBW - 500mA -

(power supply to be ordered separately)

83 92 601	○	46W	RGBW	13°
83 92 603	○	46W	RGBW	26°
83 92 607	○	46W	RGBW	Elliptical
83 92 608	○	46W	RGBW	40°

ACCESSORIES

89 17 006	●	IP68 connector for 2x0,75 mm ² cable
89 17 012	●	IP68 connector for 4x1,5 mm ² cable
89 56 307	●	IP20 Power supply (24V DC - 75W)
89 56 127	●	IP67 Power supply (24V DC - 75W)
89 56 074	●	IP67 Power supply (24V DC - 150W)
ON/OFF		Further power supplies are available on page 105
RGBW		Control systems for dynamic light on page 102

● Product available on request until the end of stocks

NANO ceiling recessed



IP68 Full Dry (2m), IK 07

LED white: 0,5 m cable length

platek.eu/NANOINOX

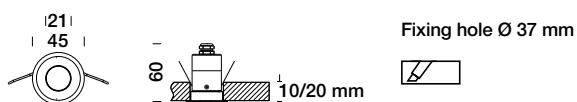

1 LED white - 700mA - (power supply to be ordered separately)
LED Data= 3000K (250 lm) - 4000K (260 lm)

84 31 011	●	2W	3000K (175 lm)	14°
84 31 013	●	2W	3000K (160 lm)	21°
84 31 018	●	2W	3000K (150 lm)	38°
84 31 061	○	2W	4000K (180 lm)	14°
84 31 063	○	2W	4000K (170 lm)	21°
84 31 068	○	2W	4000K (155 lm)	38°

ACCESSORIES

89 17 006	●	IP68 connector for 2x0,75 mm ² cable
89 17 013	●	IP68 Micro Paguro connector for 2x1,5 mm ² cable
89 56 090	●	IP67 Power supply (700mA - 14W)
89 56 117	●	IP67 Power supply (700mA - 30W)
ON/OFF		Further power supplies are available on page 105

● Product available in stock

○ Product available on request

MICRO ceiling recessed



IP68 Full Dry (2m), IK 08

LED white: 0,5 m cable length
LED RGBW: 1 m cable length

platek.eu/MICRO

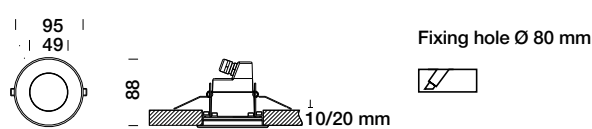

3 LED white - 220-240V 0/50/60Hz TRIAC dimmable
LED Data= 3000K (565 lm) - 4000K (593 lm)

84 30 911	○	5,9W	3000K (465 lm)	12°
84 30 913	○	5,9W	3000K (435 lm)	33°
84 30 918	●	5,9W	3000K (440 lm)	44°
84 30 961	○	5,9W	4000K (485 lm)	12°
84 30 963	○	5,9W	4000K (450 lm)	33°
84 30 968	○	5,9W	4000K (460 lm)	44°

1 LED white - 700mA - (power supply to be ordered separately)
LED Data= 3000K (250 lm) - 4000K (260 lm)

84 30 019	○	2W	3000K (125 lm)	Asymmetric
84 30 069	○	2W	4000K (130 lm)	Asymmetric

4 LED RGBW - 500mA - (power supply to be ordered separately)

83 30 101	○	5,8W	RGBW	12°
83 30 103	○	5,8W	RGBW	33°
83 30 108	○	5,8W	RGBW	44°

ACCESSORIES

89 17 014	●	IP68 connector for 3x1,5 mm ² cable
89 17 004	●	IP68 IN/OUT connector for 3x4 mm ² cable
89 56 090	●	IP67 Power supply (700mA - 14W)
89 56 117	●	IP67 Power supply (700mA - 30W)
ON/OFF		Further power supplies are available on page 105
RGBW		Control systems for dynamic light on page 102

● Product available on request until the end of stocks

MINI ceiling recessed



IP68 (2m), IK 10

LED white: 1 m cable length
LED RGBW: 1 m cable length

platek.eu/MINI

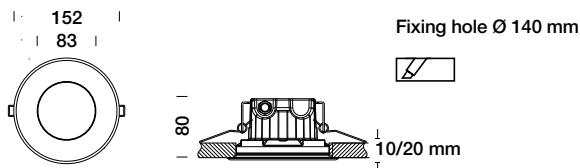

6 LED white - 220-240V 0/50/60Hz

TRIAC dimmable

LED Data= 3000K (1128 lm) - 4000K (1173 lm)

84 29 611	○	11W	3000K (955 lm)	9°
84 29 613	●	11W	3000K (855 lm)	28°
84 29 618	○	11W	3000K (775 lm)	44°
84 29 661	○	11W	4000K (995 lm)	9°
84 29 663	○	11W	4000K (890 lm)	28°
84 29 668	○	11W	4000K (805 lm)	44°

8 LED RGBW - 500mA -

(power supply to be ordered separately)

83 29 201	○	11,5W	RGBW	9°
83 29 203	○	11,5W	RGBW	28°
83 29 208	○	11,5W	RGBW	45°

ACCESSORIES

89 18 750	●	Elliptical filter
89 18 755	●	Sandblasted filter
89 17 014	●	IP68 connector for 3x1,5 mm ² cable
89 17 004	●	IP68 IN/OUT connector for 3x4 mm ² cable
RGBW		Control systems for dynamic light on page 102

OBLÒ ceiling recessed



IP65, IK 08

LED white: 0,5 m cable length

platek.eu/OBLO

other colours available on request with no price increase

.01 black; .02 white; .06 grey; .07 corten; .08 anthracite; .09 bronze

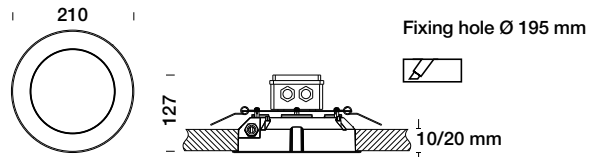

COB LED white - 220-240V 50/60Hz

LED Data= 3000K (2400 lm) - 4000K (2498 lm)

84 88 518	○	18,5W	3000K (1910 lm)	108°
84 88 568	○	18,5W	4000K (1990 lm)	108°

COB LED white - 220-240V 50/60Hz

LED Data= 3000K (3200 lm) - 4000K (3328 lm)

84 88 718	○	27W	3000K (2700 lm)	108°
84 88 768	○	27W	4000K (2800 lm)	108°

12 LED white - 220-240V 0/50/60Hz

LED Data= 3000K (2160 lm) - 4000K (2246 lm)

84 88 411	○	21W	3000K (1935 lm)	9°
84 88 413	○	21W	3000K (1810 lm)	28°
84 88 418	○	21W	3000K (1615 lm)	45°
84 88 417	○	21W	3000K (1505 lm)	Elliptical
84 88 461	○	21W	4000K (2010 lm)	9°
84 88 463	○	21W	4000K (1880 lm)	28°
84 88 468	○	21W	4000K (1680 lm)	45°
84 88 467	○	21W	4000K (1565 lm)	Elliptical

ACCESSORIES

89 17 004	●	IP68 IN/OUT connector for 3x4 mm ² cable
89 18 655	●	Sandblasted filter

OBLÒ ceiling recessed



IP65, IK 08

LED RGBW: 0,5 m

platek.eu/OBLO

other colours available on request with no price increase
 .01 black; .02 white; .06 grey;
 .07 corten; .08 anthracite; .09 bronze

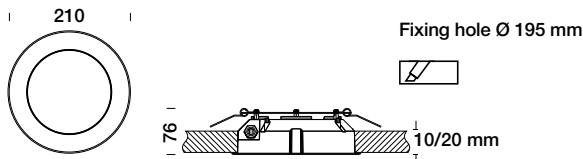

16 LED RGBW - 350mA - (power supply to be ordered separately)

83 88 401	○	16W	RGBW	9°
83 88 403	○	16W	RGBW	28°
83 88 408	○	16W	RGBW	45°
83 88 407	○	16W	RGBW	Elliptical

PIX downlight / applique

PIX 26

PIX 40



IP65, IK 07

platek.eu/PIX

available colours

.06 grey

other colours available on request with no price increase
 .01 black; .02 white; .07 corten
 .08 anthracite; .09 bronze

PIX 26

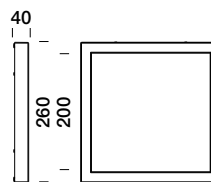

PIX 40

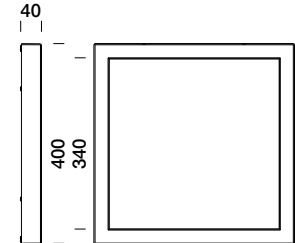

PIX 26 - LED white - 220-240V 0/50/60Hz
 LED Data= 3000K (730 lm) - 4000K (759 lm)

50 26 316	●	9,2W	3000K (500 lm)	Diffuse 260 mm
50 26 366	○	9,2W	4000K (520 lm)	Diffuse 260 mm

PIX 26 - LED white - 220-240V 0/50/60Hz
 LED Data= 3000K (875 lm) - 4000K (910 lm)

50 26 416	●	13,5W	3000K (620 lm)	Diffuse 260 mm
50 26 466	○	13,5W	4000K (645 lm)	Diffuse 260 mm

PIX 40 - LED white - 220-240V 0/50/60Hz
 LED Data= 3000K (2020 lm) - 4000K (2100 lm)

50 40 316	●	18W	3000K (1120 lm)	Diffuse 400 mm
		25W	3000K (1400 lm)	Diffuse 400 mm
50 40 366	○	18W	4000K (1160 lm)	Diffuse 400 mm
		25W	4000K (1455 lm)	Diffuse 400 mm

PIX 40 - LED white - 220-240V 0/50/60Hz
 1-10V Dimmable
 LED Data= 3000K (2020 lm) - 4000K (2100 lm)

50 40 416	○	18W	3000K (1120 lm)	Diffuse 400 mm
		25W	3000K (1400 lm)	Diffuse 400 mm
50 40 466	○	18W	4000K (1160 lm)	Diffuse 400 mm
		25W	4000K (1455 lm)	Diffuse 400 mm

ACCESSORIES

89 18 655	●	Sandblasted filter
-----------	---	--------------------

RGBW Control systems for dynamic light on page 102

SPOT 100 downlight



IP65, IK 07

platek.eu/SPOT

other colours available on request with no price increase
 .01 black; .02 white; .06 grey;
 .07 corten; .08 anthracite; .09 bronze

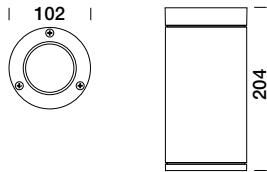

3 LED white - 220-240V 0/50/60Hz ⊕
 LED Data= 3000K (565 lm) - 4000K (588 lm)

84 27 113	●	4,5W	3000K (435 lm)	33°
84 27 118	●	4,5W	3000K (440 lm)	44°
84 27 163	●	4,5W	4000K (450 lm)	33°
84 27 168	●	4,5W	4000K (460 lm)	44°

4 LED RGBW - 500mA - ⚡
 (power supply to be ordered separately)

83 27 103	●	5,8W	RGBW	33°
83 27 108	●	5,8W	RGBW	44°

ACCESSORIES

89 18 780	●	Elliptical filter
89 18 785	●	Sandblasted filter
89 18 786	●	Honeycomb grid
89 18 787	●	Antiglare deflector
RGBW		Control systems for dynamic light on page 102

● Product available in stock

○ Product available on request

SPOT 200 downlight



IP65, IK 10

platek.eu/SPOT

other colours available on request with no price increase
 .01 black; .02 white; .06 grey;
 .07 corten; .08 anthracite; .09 bronze

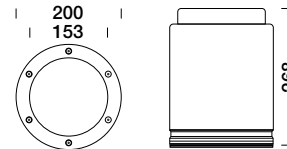

12 LED white - 220-240V 50/60Hz ⊕
 LED Data= 3000K (2160 lm) - 4000K (2246 lm)

84 26 413	○	21W	3000K (1935 lm)	28°
84 26 418	○	21W	3000K (1615 lm)	45°
84 26 463	○	21W	4000K (2015 lm)	28°
84 26 468	○	21W	4000K (1680 lm)	45°

ACCESSORIES

89 18 650	●	Elliptical filter
89 18 655	●	Sandblasted filter

○ Product available on request until the end of stocks

MINI ONE downlight



IP65, IK 07

platek.eu/MINIONE

available colours

.06 grey; .08 anthracite

other colours available on request with no price increase

.01 black; .02 white;

.07 corten; .09 bronze

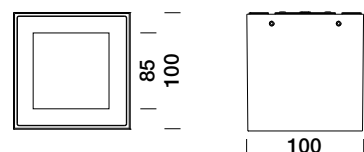

1 LED white - 220-240V 0/50/60Hz ⊕
LED Data= 3000K (600 lm) - 4000K (624 lm)

10 10 615	○	7,8W	3000K (670 lm)	Diffuse
10 11 615	●	7,8W	3000K (430 lm)	Diffuse Sandblasted
10 10 665	○	7,8W	4000K (720 lm)	Diffuse
10 11 665	○	7,8W	4000K (450 lm)	Diffuse Sandblasted

ONE 2.0 downlight



IP65, IK 07

platek.eu/ONE

available colours

.06 grey; .08 anthracite

other colours available on request with no price increase

.01 black; .02 white;

.07 corten; .09 bronze

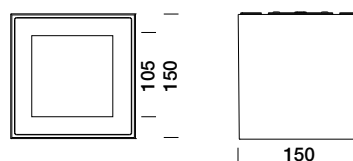

COB LED white - 220-240V 50/60Hz ⊕
Integral DALI driver
LED Data= 3000K (3695 lm) - 4000K (3840 lm)

15 15 513	○	27W	3000K (2750 lm)	Diffuse
15 16 513	●	27W	3000K (2550 lm)	Diffuse Sandblasted
15 15 563	○	27W	4000K (2860 lm)	Diffuse
15 16 563	○	27W	4000K (2650 lm)	Diffuse Sandblasted

MINI SPECIAL downlight



IP65, IK 05

platek.eu/MINISPECIAL

available colours

.06 grey; .08 anthracite

other colours available on request with no price increase

.01 black; .02 white;

.07 corten; .09 bronze

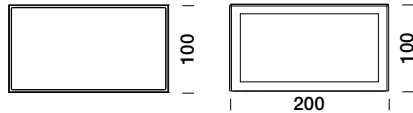

1 LED white - 220-240V 0/50/60Hz \oplus

LED Data= 3000K (1000 lm) - 4000K (1040 lm)

10 20 610	<input type="radio"/>	10W	3000K (750 lm)	75°
10 21 610	<input checked="" type="radio"/>	10W	3000K (550 lm)	Diffuse Sandblasted
10 20 660	<input type="radio"/>	10W	4000K (810 lm)	75°
10 21 660	<input type="radio"/>	10W	4000K (570 lm)	Diffuse Sandblasted

SPECIAL downlight



IP65, IK 05

platek.eu/SPECIAL

other colours available on request with no price increase

.01 black; .02 white; .06 grey;

.07 corten; .08 anthracite; .09 bronze

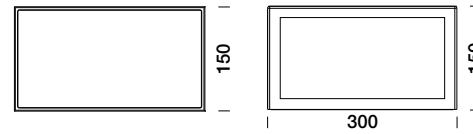

COB LED white - 220-240V 50/60Hz \oplus

LED Data= 3000K (3200 lm) - 4000K (3329 lm)

15 35 610	<input type="radio"/>	27W	3000K (2690 lm)	94°
15 36 610	<input type="radio"/>	27W	3000K (2715 lm)	Diffuse Sandblasted
15 35 660	<input type="radio"/>	27W	4000K (2800 lm)	94°
15 36 660	<input type="radio"/>	27W	4000K (2825 lm)	Diffuse Sandblasted

CIRCUS downlight



IP65, IK 08

platek.eu/CIRCUS

other colours available on request with no price increase
 .01 black; .02 white; .06 grey;
 .07 corten; .08 anthracite; .09 bronze

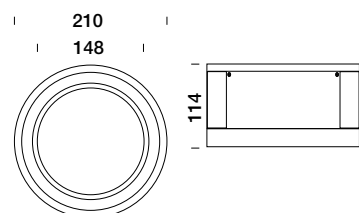

COB LED white - 220-240V 50/60Hz \oplus
 LED Data= 3000K (1740 lm) - 4000K (1810 lm)

45 20 318	○	14W	3000K (1740 lm)	Diffuse
45 20 368	○	14W	4000K (1830 lm)	Diffuse

COB LED white - 220-240V 50/60Hz \oplus
 LED Data= 3000K (2610 lm) - 4000K (2714 lm)

45 20 518	○	18,5W	3000K (1850 lm)	Diffuse
45 20 568	○	18,5W	4000K (1920 lm)	Diffuse

ACCESSORIES

89 54 001.01	●	Decorative ring - black
89 54 001.02	●	Decorative ring - white
89 54 001.04	○	Decorative ring - stainless steel finish
89 54 001.06	●	Decorative ring - grey
89 54 001.70	○	Decorative ring - red

● Product available in stock

○ Product available on request

Downlight

Firenze

Athen

Sevilla



IP65, IK 05

other colours available on request with no price increase
 .01 black; .02 white; .06 grey
 .07 corten; .08 anthracite; .09 bronze

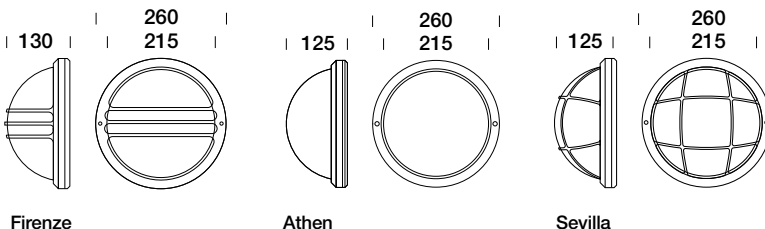

FIRENZE - LED white - 220-240V 0/50/60Hz \oplus
 LED Data= 3000K (2500 lm) - 4000K (2600 lm)

61 04 118	●	16,5W	3000K (1400 lm)	Diffuse	Opal
61 04 168	●	16,5W	4000K (1450 lm)	Diffuse	Opal

ATHEN - LED white - 220-240V 0/50/60Hz \oplus
 LED Data= 3000K (2500 lm) - 4000K (2600 lm)

72 04 118	●	16,5W	3000K (1400 lm)	Diffuse	Opal
72 04 168	●	16,5W	4000K (1450 lm)	Diffuse	Opal

SEVILLA - LED white - 220-240V 0/50/60Hz \oplus
 LED Data= 3000K (2500 lm) - 4000K (2600 lm)

73 04 118	●	16,5W	3000K (1400 lm)	Diffuse	Opal
73 04 168	●	16,5W	4000K (1450 lm)	Diffuse	Opal

● Product available on request until the end of stocks

BLEND applique design by Marco Acerbis



IP65, IK 05

platek.eu/BLEND

available colours
.02 white; .06 grey
other colours available on request with
no price increase
.01 black; .07 corten;
.08 anthracite; .09 bronze

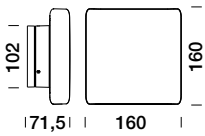

4 LED white - single emission
220-240V 50/60Hz ⊕
DALI driver on request
LED Data= 3000K (980 lm) - 4000K (1060 lm)

16 10 117	●	10W	3000K (700 lm)	53°
16 10 167	○	10W	4000K (728 lm)	53°

2 x 4 LED white - double emission
220-240V 50/60Hz ⊕
DALI driver on request
LED Data= 3000K (1950 lm) - 4000K (2109 lm)

16 10 217	●	19W	3000K (1395 lm)	53°
16 10 267	○	19W	4000K (1450 lm)	53°

BLEND 360° applique design by Marco Acerbis



IP65, IK 05

platek.eu/BLEND

available colours
.02 white; .06 grey
other colours available on request with
no price increase
.01 black; .07 corten;
.08 anthracite; .09 bronze

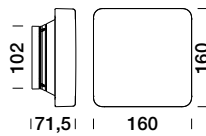

8 LED white - 360° emission
220-240V 50/60Hz ⊕
DALI driver on request
LED Data= 3000K (1470 lm) - 4000K (1590 lm)

16 10 616	●	13,5W	3000K (1060 lm)	Diffuse
16 10 666	○	13,5W	4000K (1100 lm)	Diffuse

MINI ONE applique



IP65, IK 07

platek.eu/MINIONE

available colours

.06 grey; .08 anthracite

other colours available on request with no price increase

.01 black; .02 white;

.07 corten; .09 bronze

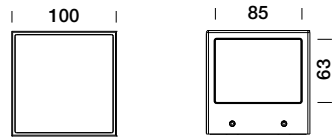

MINI ONE 1 opening

LED white - 220-240V 0/50/60Hz ⊕

10 09 616	●	2,9W	3000K (90 lm)	1 LED	50°
10 11 611	●	7,8W	3000K (195 lm)	1 LED	Sandblasted
10 10 111	●	6,2W	3000K (465 lm)	3 LED	12°
10 10 113	●	6,2W	3000K (435 lm)	3 LED	33°
10 09 666	○	2,9W	4000K (90 lm)	1 LED	50°
10 11 661	○	7,8W	4000K (200 lm)	1 LED	Sandblasted
10 10 161	○	6,2W	4000K (485 lm)	3 LED	12°
10 10 163	○	6,2W	4000K (455 lm)	3 LED	33°

MINI ONE 2 openings

LED white - 220-240V 0/50/60Hz ⊕

10 09 617	●	4,7W	3000K (185 lm)	2 LED	50°
10 11 612	●	7,8W	3000K (440 lm)	1 LED	Sandblasted
10 09 667	○	4,7W	4000K (190 lm)	2 LED	50°
10 11 662	○	7,8W	4000K (455 lm)	1 LED	Sandblasted

MINI ONE 4 openings

LED white - 220-240V 0/50/60Hz ⊕

10 09 618	○	7,6W	3000K (385 lm)	4 LED	50°
10 11 614	○	7,8W	3000K (520 lm)	1 LED	Sandblasted
10 09 668	○	7,6W	4000K (465 lm)	4 LED	50°
10 11 664	○	7,8W	4000K (540 lm)	1 LED	Sandblasted

MINI ONE with lenses

LED white - 220-240V 0/50/60Hz ⊕

10 09 611	○	2,9W	3000K (15 lm)	1 LED	1 Lens
10 09 612	●	4,7W	3000K (30 lm)	2 LED	2 Lenses
10 09 614	○	7,6W	3000K (65 lm)	4 LED	4 Lenses
10 09 615	●	4,7W	3000K (140 lm)	2 LED	1 Lens / 1 Opening
10 09 661	○	2,9W	4000K (15 lm)	1 LED	1 Lens
10 09 662	○	4,7W	4000K (30 lm)	2 LED	2 Lenses
10 09 664	○	7,6W	4000K (65 lm)	4 LED	4 Lenses
10 09 665	○	4,7W	4000K (145 lm)	2 LED	1 Lens / 1 Opening

ONE 2.0 applique



IP65, IK 08

platek.eu/ONE

available colours

.06 grey; .08 anthracite

other colours available on request with no price increase

.01 black; .02 white;

.07 corten; .09 bronze

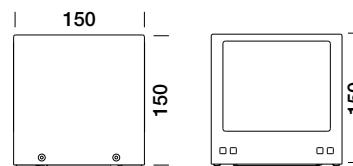

ONE 1 opening

COB LED white - 220-240V 0/50/60Hz ⊕

LED Data= 3000K (1670 lm) - 4000K (1735 lm)

15 15 216	●	18,5W	3000K (760 lm)		
15 16 216	●	18,5W	3000K (450lm)		Sandblasted
15 15 266	○	18,5W	4000K (790 lm)		
15 16 266	○	18,5W	4000K (470 lm)		Sandblasted

ONE 2 openings

COB LED white - 220-240V 0/50/60Hz ⊕

LED Data= 3000K (3340 lm) - 4000K (3470 lm)

15 15 217	●	32W	3000K (1520 lm)		
15 16 217	●	32W	3000K (900 lm)		Sandblasted
15 15 267	○	32W	4000K (1580 lm)		
15 16 267	○	32W	4000K (935 lm)		Sandblasted

ONE with lenses

COB LED white - 220-240V 0/50/60Hz ⊕

LED Data= 3000K (135 lm / LED) - 4000K (140 lm / LED)

15 15 211	●	9W	3000K (70 lm)	1 Lens	
15 15 212	●	15W	3000K (140 lm)	2 Lenses	
15 15 214	●	30W	3000K (280 lm)	4 Lenses	
15 15 215	●	25W	3000K (70 / 760 lm)	1 Lens / 1 Opening	
15 15 261	○	9W	4000K (73 lm)	1 Lenses	
15 15 262	○	15W	4000K (145 lm)	2 Lenses	
15 15 264	○	30W	4000K (290 lm)	4 Lenses	
15 15 265	○	25W	4000K (73 / 790 lm)	1 Lens / 1 Opening	

MINI SPECIAL applique



IP65, IK 05

platek.eu/MINISPECIAL

available colours
 .02 white .06 grey;
 .08 anthracite; .09 bronze
 other colours available on request with
 no price increase
 .01 black; .07 corten

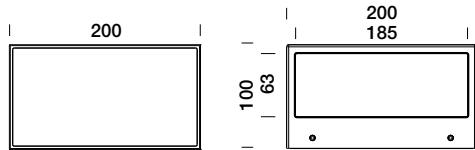

MINI SPECIAL 1 opening

1 LED white - 220-240V 0/50/60Hz ⊕
 LED Data= 3000K (1000 lm) - 4000K (1040 lm)

10 20 611	●	10W	3000K (910 lm)	
10 21 611	●	10W	3000K (785 lm)	Sandblasted
10 20 661	○	10W	4000K (945 lm)	
10 21 661	○	10W	4000K (815 lm)	Sandblasted

MINI SPECIAL 1 opening

4 LED white - 220-240V 0/50/60Hz ⊕
 LED Data= 3000K (1875 lm) - 4000K (1950 lm)

10 20 911	●	19,5W	3000K (1600 lm)	Asymmetric
10 20 961	○	19,5W	4000K (1670 lm)	Asymmetric

MINI SPECIAL 2 openings

2 LED white - 220-240V 0/50/60Hz ⊕
 LED Data= 3000K (2000 lm) - 4000K (2080 lm)

10 20 612	●	21W	3000K (1770 lm)	
10 21 612	●	21W	3000K (1640 lm)	Sandblasted
10 20 662	○	21W	4000K (1845 lm)	
10 21 662	○	21W	4000K (1705 lm)	Sandblasted

SPECIAL applique



IP65, IK 05

platek.eu/SPECIAL

other colours available on request with
 no price increase
 .01 black; .02 white; .06 grey
 .07 corten; .08 anthracite; .09 bronze

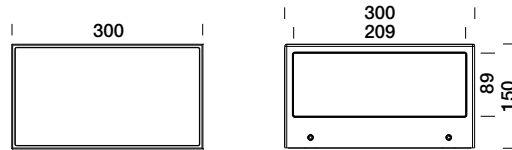

SPECIAL 1 opening

1 COB LED white - 220-240V 50/60Hz ⊕
 LED Data= 3000K (2400 lm) - 4000K (2496 lm)

15 35 611	○	19W	3000K (1940 lm)	
15 36 611	○	19W	3000K (1690 lm)	Sandblasted
15 35 661	○	19W	4000K (2015 lm)	
15 36 661	○	19W	4000K (1760 lm)	Sandblasted

SPECIAL 2 openings

2 LED white - 220-240V 0/50/60Hz ⊕
 LED Data= 3000K (4800 lm) - 4000K (4992 lm)

15 35 612	○	37W	3000K (3880 lm)	
15 36 612	○	37W	3000K (3390 lm)	Sandblasted
15 35 662	○	37W	4000K (4035 lm)	
15 36 662	○	37W	4000K (3525 lm)	Sandblasted

MOON applique design by Lundbergdesign

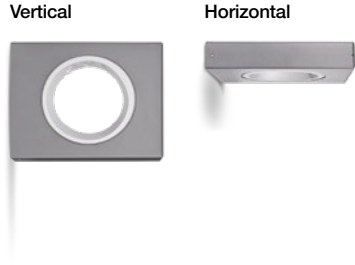

IP65, IK 05
 LED white: 0,5 m cable length
 platek.eu/MOON

other colours available on request with no price increase
 .01 black; .02 white; .06 grey
 .07 corten; .08 anthracite; .09 bronze

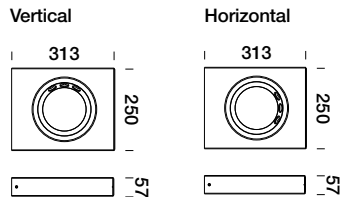

MOON vertical - single emission
 3 LED white - 220-240V 0/50/60Hz
 LED Data= 3000K (750 lm) - 4000K (780 lm)

19 66 611	○	7,9W	3000K (395 lm)	Asymmetric
19 66 616	○	7,9W	4000K (410 lm)	Asymmetric

MOON vertical - double emission
 6 LED white - 220-240V 0/50/60Hz
 LED Data= 3000K (1500 lm) - 4000K (1560 lm)

19 66 621	○	15W	3000K (790 lm)	Symmetric
19 66 626	○	15W	4000K (820 lm)	Symmetric

MOON horizontal - single emission
 3 LED white - 220-240V 0/50/60Hz
 LED Data= 3000K (750 lm) - 4000K (780 lm)

19 67 611	○	7,9W	3000K (395 lm)	Asymmetric
19 67 616	○	7,9W	4000K (410 lm)	Asymmetric

MOON horizontal - double emission
 6 LED white - 220-240V 0/50/60Hz
 LED Data= 3000K (1500 lm) - 4000K (1560 lm)

19 67 621	○	15W	3000K (790 lm)	Symmetric
19 67 626	○	15W	4000K (820 lm)	Symmetric

TETRA 75 applique



IP65, IK 07
 platek.eu/TETRA

other colours available on request with no price increase
 .01 black; .02 white; .06 grey
 .07 corten; .08 anthracite; .09 bronze

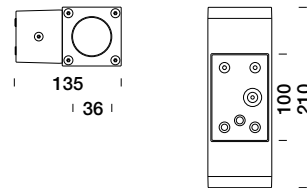

TETRA single emission
 3 LED white - 220-240V 0/50/60Hz
 LED Data= 3000K (475 lm) - 4000K (494 lm)

84 38 111	●	3,9W	3000K (465 lm)	12°
84 38 118	●	3,9W	3000K (445 lm)	44°
84 38 161	●	3,9W	4000K (485 lm)	12°
84 38 168	●	3,9W	4000K (460 lm)	44°

TETRA double emission
 2 x 3 LED white - 220-240V 0/50/60Hz
 LED Data= 3000K (950 lm) - 4000K (988 lm)

84 39 111	●	6,9W	3000K (930 lm)	12°
84 39 118	●	6,9W	3000K (970 lm)	44°
84 39 115	●	6,9W	3000K (910 lm)	12/44°
84 39 161	●	6,9W	4000K (970 lm)	12°
84 39 168	●	6,9W	4000K (920 lm)	44°
84 39 165	●	6,9W	4000K (945 lm)	12/44°

TETRA 140 applique



IP65, IK 10

platek.eu/TETRA

other colours available on request with
no price increase
.01 black; .02 white; .06 grey
.07 corten; .08 anthracite; .09 bronze

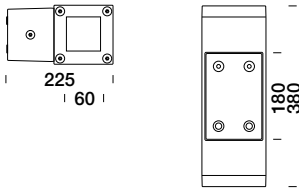

TETRA single emission

9 LED white - 220-240V 0/50/60Hz

LED Data= 3000K (1125 lm) - 4000K (1170 lm)

84 36 311	●	10,5W	3000K (1005 lm)	9°
84 36 318	●	10,5W	3000K (935 lm)	45°
84 36 317	●	10,5W	3000K (915 lm)	Elliptical
84 36 361	●	10,5W	4000K (1055 lm)	9°
84 36 368	●	10,5W	4000K (970 lm)	45°
84 36 367	●	10,5W	4000K (950 lm)	Elliptical

TETRA double emission

2 x 9 LED white - 220-240V 0/50/60Hz

LED Data= 3000K (2250 lm) - 4000K (2340 lm)

84 37 311	●	21W	3000K (2020 lm)	9°
84 37 318	●	21W	3000K (1870 lm)	45°
84 37 317	●	21W	3000K (1830 lm)	Elliptical
84 37 315	●	21W	3000K (1340 lm)	9°/45°
84 37 361	●	21W	4000K (2100 lm)	9°
84 37 368	●	21W	4000K (1940 lm)	45°
84 37 367	●	21W	4000K (1900 lm)	Elliptical
84 37 365	●	21W	4000K (1530 lm)	9°/45°

MONACO MEDIUM applique

MONACO 200 applique



IP65, IK 08

available colours
 .06 grey; .08 anthracite
 other colours available on request with
 no price increase
 .01 black; .02 white;
 .07 corten; .09 bronze

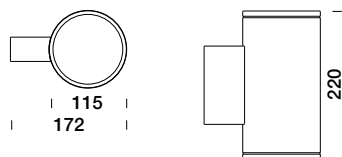

1 x LED white - single emission
 220-240V 50/60Hz \oplus
 1 LED Data= 3000K (1250 lm) - 4000K (1365 lm)

53 80 111	●	11W	3000K (480 lm)	13°
53 80 118	●	11W	3000K (965 lm)	60°
53 80 161	○	11W	4000K (495 lm)	13°
53 80 168	○	11W	4000K (1000 lm)	60°

2 x LED white - double emission
 220-240V 50/60Hz \oplus
 LED Data= 3000K (2500 lm) - 4000K (2730 lm)

53 80 211	●	22W	3000K (950 lm)	13°
53 80 218	●	22W	3000K (1930 lm)	60°
53 80 215	○	22W	3000K (1440 lm)	13° / 60°
53 80 261	○	22W	4000K (990 lm)	13°
53 80 268	○	22W	4000K (2005 lm)	60°
53 80 265	○	22W	4000K (1495 lm)	13° / 60°

IP65, IK 10

other colours available on request with
 no price increase
 .01 black; .02 white; .06 grey
 .07 corten; .08 anthracite; .09 bronze

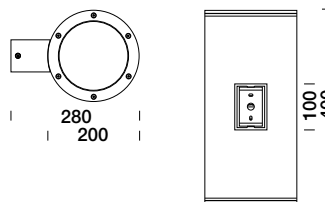

12 LED white - single emission
 220-240V 50/60Hz \oplus
 LED Data= 3000K (2160 lm) - 4000K (2246 lm)

84 42 411	○	21W	3000K (1935 lm)	9°
84 42 418	○	21W	3000K (1615 lm)	49°
84 42 461	○	21W	4000K (2010 lm)	9°
84 42 468	○	21W	4000K (1680 lm)	49°

2 x 12 LED white - double emission
 220-240V 50/60Hz \oplus
 LED Data= 3000K (4320 lm) - 4000K (4493 lm)

84 43 411	○	42W	3000K (3870 lm)	9°
84 43 418	○	42W	3000K (3230 lm)	49°
84 43 415	○	42W	3000K (3550 lm)	9° / 49°
84 43 461	○	42W	4000K (4025 lm)	9°
84 43 468	○	42W	4000K (3360 lm)	49°
84 43 465	○	42W	4000K (3700 lm)	9° / 49°

ACCESSORIES

89 18 650	●	Elliptical filter
89 18 655	●	Sandblasted filter

BALI applique



IP65, IK 10

other colours available on request with
no price increase
.01 black; .02 white; .06 grey
.07 corten; .08 anthracite; .09 bronze

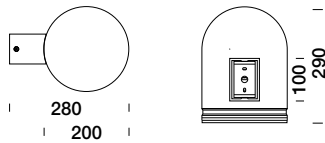

COB LED white

220-240V 50/60Hz ⊕

LED Data= 3000K (3200 lm) - 4000K (3328 lm)

55 33 613	● 27W	3000K (2535 lm)	38°
55 33 663	● 27W	4000K (2650 lm)	38°

LED white

220-240V 0/50/60Hz ⊕

4 LED Data= 3000K (4320 lm) - 4000K (4493 lm)

84 46 719	● 36W	3000K (3330 lm)	Street
84 46 769	● 36W	4000K (3330 lm)	Street

ACCESSORIES

89 18 650	● Elliptical filter
89 18 655	● Sandblasted filter

● Product available in stock

○ Product available on request

● Product available on request until the end of stocks

MINI CORNICHE 100 applique



Diffuse



IP65, IK 05

LED white: 2 m cable length
LED RGBW: 2 m cable length

platek.eu/MINICORNICHE

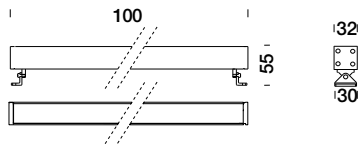

other colours available on request with no price increase

.01 black; .02 white; .06 grey
.07 corten; .08 anthracite; .09 bronze

MINI CORNICHE 300 applique



Diffuse



IP65, IK 05

LED white: 2 m cable length
LED RGBW: 2 m cable length

platek.eu/MINICORNICHE

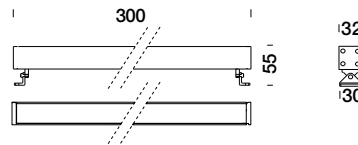

other colours available on request with no price increase

.01 black; .02 white; .06 grey
.07 corten; .08 anthracite; .09 bronze

LED white - 24V DC -

(power supply to be ordered separately)

3 LED Data= 3000K (375 lm) - 4000K (390 lm)

84 11 111	○	3,5W	3000K (250 lm)	13°
84 11 113	○	3,5W	3000K (255 lm)	26°
84 11 118	○	3,5W	3000K (230 lm)	40°
84 11 117	○	3,5W	3000K (215 lm)	Elliptical
84 11 161	○	3,5W	4000K (260 lm)	13°
84 11 163	○	3,5W	4000K (265 lm)	26°
84 11 168	○	3,5W	4000K (245 lm)	40°
84 11 167	○	3,5W	4000K (225 lm)	Elliptical

LED white - 24V DC -

(power supply to be ordered separately)

LED Data= 3000K (120 lm) - 4000K (125 lm)

84 11 116	○	1,5W	3000K (85 lm)	Diffuse Sandblasted
84 11 166	○	1,5W	4000K (90 lm)	Diffuse Sandblasted

4 LED RGBW - 500mA -

(power supply to be ordered separately)

83 91 101	○	6W	RGBW	13°
83 91 103	○	6W	RGBW	26°
83 91 107	○	6W	RGBW	Elliptical
83 91 108	○	6W	RGBW	40°

ACCESSORIES

89 17 006	●	IP68 connector for 2x0,75 mm ² cable
89 17 012	●	IP68 connector for 4x1,5 mm ² cable
89 47 005	●	Stainless steel brackets for wall mounting length 50 mm
89 47 010	●	Stainless steel brackets for wall mounting length 100 mm
89 56 104	●	IP20 Power supply (24V DC - 30W)
89 56 307	●	IP20 Power supply (24V DC - 75W)
89 56 172	●	IP67 Power supply (24V DC - 30W)
89 56 127	●	IP67 Power supply (24V DC - 75W)
89 56 074	●	IP67 Power supply (24V DC - 150W)

ON/OFF Further power supplies are available on page 105

RGBW Control systems for dynamic light on page 102

LED white - 24V DC -

(power supply to be ordered separately)

9 LED Data= 3000K (1125 lm) - 4000K (1170 lm)

84 11 311	○	9,5W	3000K (750 lm)	13°
84 11 313	○	9,5W	3000K (770 lm)	26°
84 11 318	○	9,5W	3000K (700 lm)	40°
84 11 317	○	9,5W	3000K (650 lm)	Elliptical
84 11 361	○	9,5W	4000K (780 lm)	13°
84 11 363	○	9,5W	4000K (800 lm)	26°
84 11 368	○	9,5W	4000K (730 lm)	40°
84 11 367	○	9,5W	4000K (675 lm)	Elliptical

LED white - 24V DC -

(power supply to be ordered separately)

LED Data= 3000K (560 lm) - 4000K (582 lm)

84 11 316	○	5,5W	3000K (415 lm)	Diffuse Sandblasted
84 11 366	○	5,5W	4000K (430 lm)	Diffuse Sandblasted

8 LED RGBW - 500mA -

(power supply to be ordered separately)

83 91 301	○	11,5W	RGBW	13°
83 91 303	○	11,5W	RGBW	26°
83 91 307	○	11,5W	RGBW	Elliptical
83 91 308	○	11,5W	RGBW	40°

ACCESSORIES

89 17 006	●	IP68 connector for 2x0,75 mm ² cable
89 17 012	●	IP68 connector for 4x1,5 mm ² cable
89 47 005	●	Stainless steel brackets for wall mounting length 50 mm
89 47 010	●	Stainless steel brackets for wall mounting length 100 mm
89 56 104	●	IP20 Power supply (24V DC - 30W)
89 56 307	●	IP20 Power supply (24V DC - 75W)
89 56 172	●	IP67 Power supply (24V DC - 30W)
89 56 127	●	IP67 Power supply (24V DC - 75W)
89 56 074	●	IP67 Power supply (24V DC - 150W)

ON/OFF Further power supplies are available on page 105

RGBW Control systems for dynamic light on page 102

MINI CORNICHE 600 applique



Diffuse



IP65, IK 05

LED white: 2 m cable length
LED RGBW: 2 m cable length

platek.eu/MINICORNICHE

other colours available on request with no price increase

.01 black; .02 white; .06 grey
.07 corten; .08 anthracite; .09 bronze

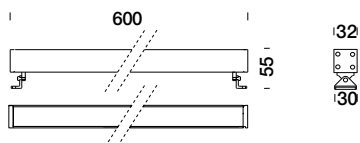

LED white - 24V DC -

(power supply to be ordered separately)

18 LED Data= 3000K (2250 lm) - 4000K (2340 lm)

84 11 511	○	18,5W	3000K (1500 lm)	13°
84 11 513	○	18,5W	3000K (1545 lm)	26°
84 11 518	○	18,5W	3000K (1400 lm)	40°
84 11 517	○	18,5W	3000K (1290 lm)	Elliptical
84 11 561	○	18,5W	4000K (1560 lm)	13°
84 11 563	○	18,5W	4000K (1605 lm)	26°
84 11 568	○	18,5W	4000K (1455 lm)	40°
84 11 567	○	18,5W	4000K (1345 lm)	Elliptical

LED white - 24V DC -

(power supply to be ordered separately)

LED Data= 3000K (1010 lm) - 4000K (1154 lm)

84 11 516	○	10,5W	3000K (825 lm)	Diffuse	Sandblasted
84 11 566	○	10,5W	4000K (860 lm)	Diffuse	Sandblasted

16 LED RGBW - 500mA -

(power supply to be ordered separately)

83 91 501	○	23W	RGBW	13°
83 91 503	○	23W	RGBW	26°
83 91 507	○	23W	RGBW	Elliptical
83 91 508	○	23W	RGBW	40°

ACCESSORIES

89 17 006	●	IP68 connector for 2x0,75 mm ² cable
89 17 012	●	IP68 connector for 4x1,5 mm ² cable
89 47 005	●	Stainless steel brackets for wall mounting length 50 mm
89 47 010	●	Stainless steel brackets for wall mounting length 100 mm
89 56 104	●	IP20 Power supply (24V DC - 30W)
89 56 307	●	IP20 Power supply (24V DC - 75W)
89 56 172	●	IP67 Power supply (24V DC - 30W)
89 56 127	●	IP67 Power supply (24V DC - 75W)
89 56 074	●	IP67 Power supply (24V DC - 150W)
ON/OFF		Further power supplies are available on page 105
RGBW		Control systems for dynamic light on page 102

● Product available in stock

○ Product available on request

MINI CORNICHE 900 applique



Diffuse



IP65, IK 05

LED white: 2 m cable length
LED RGBW: 2 m cable length

platek.eu/MINICORNICHE

other colours available on request with no price increase

.01 black; .02 white; .06 grey
.07 corten; .08 anthracite; .09 bronze

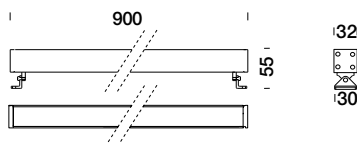

LED white - 24V DC -

(power supply to be ordered separately)

27 LED Data= 3000K (3375 lm) - 4000K (3510 lm)

84 11 711	○	29W	3000K (2255 lm)	13°
84 11 713	○	29W	3000K (2320 lm)	26°
84 11 718	○	29W	3000K (2100 lm)	40°
84 11 717	○	29W	3000K (1940 lm)	Elliptical
84 11 761	○	29W	4000K (2350 lm)	13°
84 11 763	○	29W	4000K (2415 lm)	26°
84 11 768	○	29W	4000K (2185 lm)	40°
84 11 767	○	29W	4000K (2020 lm)	Elliptical

LED white - 24V DC -

(power supply to be ordered separately)

LED Data= 3000K (1670 lm) - 4000K (1737 lm)

84 11 716	○	15,5W	3000K (1240 lm)	Diffuse	Sandblasted
84 11 766	○	15,5W	4000K (1290 lm)	Diffuse	Sandblasted

24 LED RGBW - 500mA -

(power supply to be ordered separately)

83 91 701	○	35W	RGBW	13°
83 91 703	○	35W	RGBW	26°
83 91 707	○	35W	RGBW	Elliptical
83 91 708	○	35W	RGBW	40°

ACCESSORIES

89 17 006	●	IP68 connector for 2x0,75 mm ² cable
89 17 012	●	IP68 connector for 4x1,5 mm ² cable
89 47 005	●	Stainless steel brackets for wall mounting length 50 mm
89 47 010	●	Stainless steel brackets for wall mounting length 100 mm
89 56 104	●	IP20 Power supply (24V DC - 30W)
89 56 307	●	IP20 Power supply (24V DC - 75W)
89 56 172	●	IP67 Power supply (24V DC - 30W)
89 56 127	●	IP67 Power supply (24V DC - 75W)
89 56 074	●	IP67 Power supply (24V DC - 150W)
ON/OFF		Further power supplies are available on page 105
RGBW		Control systems for dynamic light on page 102

● Product available on request until the end of stocks

MINI CORNICHE 1200 applique

TETRA CORNICHE 360 wall effect

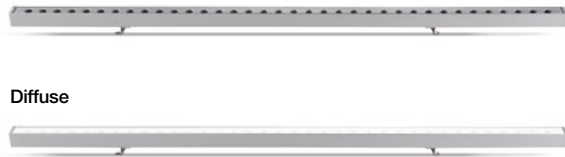

IP65, IK 05
LED white: 2 m cable length
LED RGBW: 2 m cable length

other colours available on request with no price increase
.01 black; .02 white; .06 grey
.07 corten; .08 anthracite; .09 bronze

IP66, IK 07
LED white: 1 m cable length
platek.eu/TETRACORNICHE

other colours available on request with no price increase
.01 black; .02 white; .06 grey
.07 corten; .08 anthracite; .09 bronze

platek.eu/MINICORNICHE

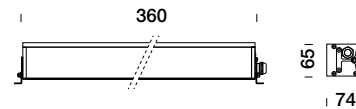
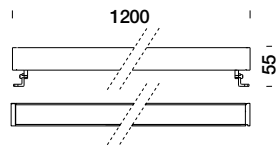

LED white - 24V DC - (power supply to be ordered separately)
36 LED Data= 3000K (4500 lm) - 4000K (4680 lm)

84 11 611	○	40W	3000K (3000 lm)	13°
84 11 613	○	40W	3000K (3090 lm)	26°
84 11 618	○	40W	3000K (2800 lm)	40°
84 11 617	○	40W	3000K (2590 lm)	Elliptical
84 11 661	○	40W	4000K (3125 lm)	13°
84 11 663	○	40W	4000K (3215 lm)	26°
84 11 668	○	40W	4000K (2900 lm)	40°
84 11 667	○	40W	4000K (2690 lm)	Elliptical

LED white - 220-240V 50/60Hz
12 LED Data= 3000K (1500 lm) - 4000K (1560 lm)

84 17 411	○	13,5W	3000K (1130 lm)	13°
84 17 413	○	13,5W	3000K (1065 lm)	26°
84 17 418	○	13,5W	3000K (950 lm)	40°
84 17 417	○	13,5W	3000K (930 lm)	Elliptical
84 17 461	○	13,5W	4000K (1175 lm)	13°
84 17 463	○	13,5W	4000K (1105 lm)	26°
84 17 468	○	13,5W	4000K (985 lm)	40°
84 17 467	○	13,5W	4000K (970 lm)	Elliptical

LED white - 24V DC - (power supply to be ordered separately)
LED Data= 3000K (2250 lm) - 4000K (2340 lm)

84 11 616	○	21W	3000K (1650 lm)	Diffuse Sandblasted
84 11 666	○	21W	4000K (1715 lm)	Diffuse Sandblasted

32 LED RGBW - 500mA - (power supply to be ordered separately)

83 91 601	○	46W	RGBW	13°
83 91 603	○	46W	RGBW	26°
83 91 608	○	46W	RGBW	40°
83 91 607	○	46W	RGBW	Elliptical

ACCESSORIES

89 17 006	●	IP68 connector for 2x0,75 mm ² cable
89 17 012	●	IP68 connector for 4x1,5 mm ² cable
89 47 005	●	Stainless steel brackets for wall mounting length 50 mm
89 47 010	●	Stainless steel brackets for wall mounting length 100 mm
89 56 104	●	IP20 Power supply (24V DC - 30W)
89 56 307	●	IP20 Power supply (24V DC - 75W)
89 56 172	●	IP67 Power supply (24V DC - 30W)
89 56 127	●	IP67 Power supply (24V DC - 75W)
89 56 074	●	IP67 Power supply (24V DC - 150W)
ON/OFF		Further power supplies are available on page 105
RGBW		Control systems for dynamic light on page 102

ACCESSORIES

89 47 055	●	Stainless steel brackets for wall mounting (±15° adjustable)
89 17 014	●	IP68 connector for 3x1,5 mm ² cable
89 17 004	●	IP68 IN/OUT connector for 3x4 mm ² cable

TETRA CORNICHE 900 wall effect



IP66, IK 07

LED white: 1 m cable length

platek.eu/TETRACORNICHE

other colours available on request with
no price increase
.01 black; .02 white; .06 grey
.07 corten; .08 anthracite; .09 bronze

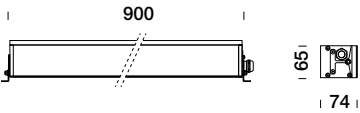

LED white - 220-240V 50/60Hz \oplus
18 LED Data= 3000K (2250 lm) - 4000K (2340 lm)

84 16 511	○	21W	3000K (1700 lm)	13°
84 16 513	○	21W	3000K (1600 lm)	26°
84 16 518	○	21W	3000K (1425 lm)	40°
84 16 517	○	21W	3000K (1400 lm)	Elliptical
84 16 561	○	21W	4000K (1765 lm)	13°
84 16 563	○	21W	4000K (1660 lm)	26°
84 16 568	○	21W	4000K (1480 lm)	40°
84 16 567	○	21W	4000K (1455 lm)	Elliptical

LED white - 220-240V 50/60Hz \oplus
36 LED Data= 3000K (4500 lm) - 4000K (4680 lm)

84 16 611	○	47W	3000K (3400 lm)	13°
84 16 613	○	47W	3000K (3200 lm)	26°
84 16 618	○	47W	3000K (2850 lm)	40°
84 16 617	○	47W	3000K (2800 lm)	Elliptical
84 16 661	○	47W	4000K (3535 lm)	13°
84 16 663	○	47W	4000K (3325 lm)	26°
84 16 668	○	47W	4000K (2960 lm)	40°
84 16 667	○	47W	4000K (2910 lm)	Elliptical

ACCESSORIES

89 47 055	●	Stainless steel brackets for wall mounting ($\pm 15^\circ$ adjustable)
89 17 014	●	IP68 connector for 3x1,5 mm ² cable
89 17 004	●	IP68 IN/OUT connector for 3x4 mm ² cable

TETRA LINEARE 360 wall effect



IP65, IK 07

other colours available on request with no price increase
 .01 black; .02 white; .06 grey
 .07 corten; .08 anthracite; .09 bronze

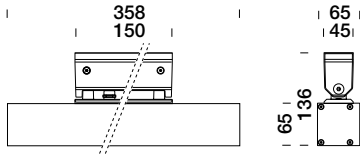

LED white - 220-240V 50/60Hz ⊕

6 LED Data= 3000K (750 lm) - 4000K (780 lm)

84 15 211	●	7,3W	3000K (565 lm)	12°
84 15 218	●	7,3W	3000K (475 lm)	40°
84 15 217	●	7,3W	3000K (465 lm)	Elliptical
84 15 261	●	7,3W	4000K (590 lm)	12°
84 15 268	●	7,3W	4000K (490 lm)	40°
84 15 267	●	7,3W	4000K (485 lm)	Elliptical

LED white - 220-240V 50/60Hz ⊕

12 LED Data= 3000K (1500 lm) - 4000K (1560 lm)

84 15 411	●	13,5W	3000K (1065 lm)	12°
84 15 418	●	13,5W	3000K (1130 lm)	40°
84 15 417	●	13,5W	3000K (920 lm)	Elliptical
84 15 461	●	13,5W	4000K (1105 lm)	12°
84 15 468	●	13,5W	4000K (1175 lm)	40°
84 15 467	●	13,5W	4000K (955 lm)	Elliptical

TETRA LINEARE 900 wall effect

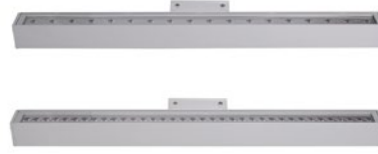

IP65, IK 07

other colours available on request with no price increase
 .01 black; .02 white; .06 grey
 .07 corten; .08 anthracite; .09 bronze

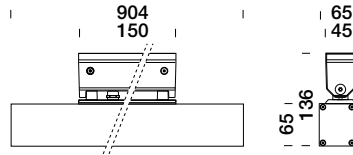

LED white - 220-240V 50/60Hz ⊕

18 LED Data= 3000K (2250 lm) - 4000K (2340 lm)

84 14 511	●	21W	3000K (1700 lm)	12°
84 14 518	●	21W	3000K (1425 lm)	40°
84 14 517	●	21W	3000K (1400 lm)	Elliptical
84 14 561	●	21W	4000K (1765 lm)	12°
84 14 568	●	21W	4000K (1480 lm)	40°
84 14 567	●	21W	4000K (1455 lm)	Elliptical

LED white - 220-240V 50/60Hz ⊕

36 LED Data= 3000K (4500 lm) - 4000K (4680 lm)

84 14 611	●	47W	3000K (3400 lm)	12°
84 14 618	●	47W	3000K (2850 lm)	40°
84 14 617	●	47W	3000K (2800 lm)	Elliptical
84 14 661	●	47W	4000K (3535 lm)	12°
84 14 668	●	47W	4000K (2960 lm)	40°
84 14 667	●	47W	4000K (1910 lm)	Elliptical

BLEND bollard design by Marco Acerbis





IP65, IK 10

IP68 connector included

available colours

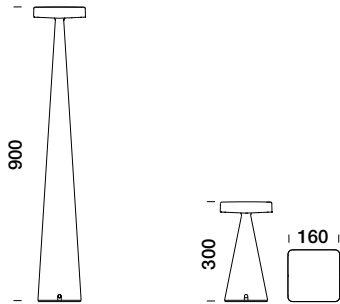
.06 grey
other colours available on request with no price increase
.01 black; .02 white;
.07 corten; .08 anthracite; .09 bronze



BLEND bollard H. 300 mm - LED white
220-240V 50/60Hz 
LED Data= 3000K (1078 lm) - 4000K (1166 lm)

16 40 519	● 10W	3000K (720 lm)
16 40 569	○ 10W	4000K (750 lm)

BLEND bollard H. 900 mm - LED white
220-240V 50/60Hz 
DALI driver on request
LED Data= 3000K (1950 lm) - 4000K (2109 lm)

16 40 619	● 19,5W	3000K (1300 lm)
16 40 669	○ 19,5W	4000K (1350 lm)

ACCESSORIES

89 50 125	● Tie-rod
-----------	-----------

● Product available in stock

○ Product available on request

TEAM bollard design by Marco Acerbis



IP66, IK 08

IP68 connector included

other colours available on request with no price increase

.01 black; .02 white; .06 grey
.07 corten; .08 anthracite; .09 bronze

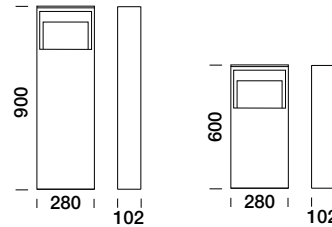

TEAM bollard H. 600 / 900 mm

single emission
LED white
220-240V 50/60Hz 
TRIAC dimmable
LED Data= 3000K (1600 lm) - 4000K (1664 lm)

34 40 419	○ 17,5W	3000K (890 lm)	H. 600 mm
34 40 469	○ 17,5W	4000K (935 lm)	H. 600 mm
34 40 619	○ 17,5W	3000K (890 lm)	H. 900 mm
34 40 669	○ 17,5W	4000K (935 lm)	H. 900 mm

TEAM bollard H. 600 / 900 mm

double emission
LED white
220-240V 50/60Hz 
TRIAC dimmable
LED Data= 3000K (3200 lm) - 4000K (3328 lm)

34 40 519	○ 32W	3000K (1785 lm)	H. 600 mm
34 40 569	○ 32W	4000K (1875 lm)	H. 600 mm
34 40 719	○ 32W	3000K (1785 lm)	H. 900 mm
34 40 769	○ 32W	4000K (1875 lm)	H. 900 mm

ACCESSORIES

89 50 130	● Tie-rod
-----------	-----------

● Product available on request until the end of stocks

ALIEN bollard



IP66, IK 10

platek.eu/ALIEN

available colours
other colours available on request with
no price increase
.01 black; .02 white; .06 grey;
.07 corten; .08 anthracite; .09 bronze

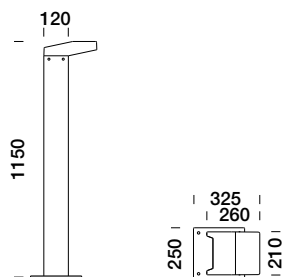

ALIEN H. 1150 mm

4 LED white - 220-240V 0/50/60Hz

LED Data= 3000K (2200 lm) - 4000K (2288 lm)

42 70 119	○	22W	3000K (1815 lm)	Street
42 70 169	○	22W	4000K (1890 lm)	Street

ACCESSORIES

89 50 090 ● Tie-rod

MOON bollard design by Lundbergdesign



IP66, IK 10

platek.eu/MOON

available colours
other colours available on request with
no price increase
.01 black; .02 white; .06 grey;
.07 corten; .08 anthracite; .09 bronze

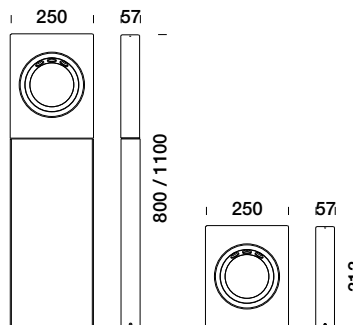

MOON H. 300 / 800 / 1100 mm

single emission

LED white - 220-240V 0/50/60Hz

3 LED Data= 3000K (750 lm) - 4000K (780 lm)

19 67 611	○	7,9W	3000K (395 lm)	H. 300 mm
19 67 616	○	7,9W	4000K (410 lm)	H. 300 mm
19 68 611	○	7,9W	3000K (395 lm)	H. 800 mm
19 68 616	○	7,9W	4000K (410 lm)	H. 800 mm
19 69 611	○	7,9W	3000K (395 lm)	H. 1100 mm
19 69 616	○	7,9W	4000K (410 lm)	H. 1100 mm

MOON H. 300 / 800 / 1100 mm

double emission

LED white - 220-240V 0/50/60Hz

6 LED Data= 3000K (1500 lm) - 4000K (1560 lm)

19 67 621	○	15W	3000K (790 lm)	H. 300 mm
19 67 626	○	15W	4000K (820 lm)	H. 300 mm
19 68 621	○	15W	3000K (790 lm)	H. 800 mm
19 68 626	○	15W	4000K (820 lm)	H. 800 mm
19 69 621	○	15W	3000K (790 lm)	H. 1100 mm
19 69 626	○	15W	4000K (820 lm)	H. 1100 mm

ACCESSORIES

89 50 070 ● Tie-rod

SLIM bollard



IP65, IK 08

platek.eu/SLIM

available colours

.06 grey; .08 anthracite; .09 bronze
other colours available on request with
no price increase
.01 black; .02 white; .07 corten;

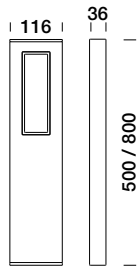

SLIM bollard H. 500 mm

LED white - 220-240V 0/50/60Hz ☐

LED Data= 3000K (1000 lm) - 4000K (1040 lm)

50 00 611	●	8,8W	3000K (540 lm)	1 opening
50 00 612	●	8,8W	3000K (600 lm)	2 openings
50 00 661	○	8,8W	4000K (565 lm)	1 opening
50 00 662	○	8,8W	4000K (625 lm)	2 openings

SLIM bollard H. 800 mm

LED white - 220-240V 0/50/60Hz ☐

LED Data= 3000K (1000 lm) - 4000K (1040 lm)

50 10 611	●	8,8W	3000K (540 lm)	1 opening
50 10 612	●	8,8W	3000K (600 lm)	2 openings
50 10 661	○	8,8W	4000K (565 lm)	1 opening
50 10 662	○	8,8W	4000K (625 lm)	2 openings

ACCESSORIES

89 50 025	●	Tie-rod
-----------	---	---------

MINI ONE bollard



IP65, IK 07

platek.eu/MINIONE

available colours

.06 grey; .08 anthracite
other colours available on request with
no price increase
.01 black; .02 white;
.07 corten; .09 bronze

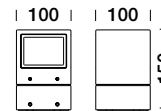
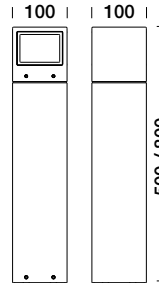

MINI ONE bollard H. 150 mm

1 LED white - 220-240V 0/50/60Hz ⊕

LED Data= 3000K (600 lm) - 4000K (624 lm)

10 15 611	●	7,8W	3000K (330 lm)	1 opening
10 15 612	○	7,8W	3000K (525 lm)	2 openings
10 15 614	○	7,8W	3000K (620 lm)	4 openings
10 15 661	○	7,8W	4000K (340 lm)	1 opening
10 15 662	○	7,8W	4000K (550 lm)	2 openings
10 15 664	○	7,8W	4000K (650 lm)	4 openings

MINI ONE bollard H. 500 mm

1 LED white - 220-240V 0/50/60Hz ⊕

LED Data= 3000K (1000 lm) - 4000K (1040 lm)

10 50 611	●	10,5W	3000K (330 lm)	1 opening
10 50 612	○	10,5W	3000K (525 lm)	2 openings
10 50 614	○	10,5W	3000K (620 lm)	4 openings
10 50 661	○	10,5W	4000K (245 lm)	1 opening
10 50 662	○	10,5W	4000K (550 lm)	2 openings
10 50 664	○	10,5W	4000K (650 lm)	4 openings

MINI ONE bollard H. 800 mm

1 LED white - 220-240V 0/50/60Hz ⊕

LED Data= 3000K (1000 lm) - 4000K (1040 lm)

10 80 611	○	10,5W	3000K (330 lm)	1 opening
10 80 612	○	10,5W	3000K (525 lm)	2 openings
10 80 614	○	10,5W	3000K (620 lm)	4 openings
10 80 661	○	10,5W	4000K (245 lm)	1 opening
10 80 662	○	10,5W	4000K (550 lm)	2 openings
10 80 664	○	10,5W	4000K (650 lm)	4 openings

ACCESSORIES

89 17 014	●	IP68 connector for 3x1,5 mm ² cable
89 17 004	●	IP68 IN/OUT connector for 3x4 mm ² cable
89 50 045	●	Tie-rod
90 05 190	●	Spike

MICRO MENHIR bollard design by Lundbergdesign



IP65, IK 08

platek.eu/MICROMENHIR

available colours

.06 grey; .08 anthracite; .09 bronze
other colours available on request with
no price increase
.01 black; .02 white; .07 corten;

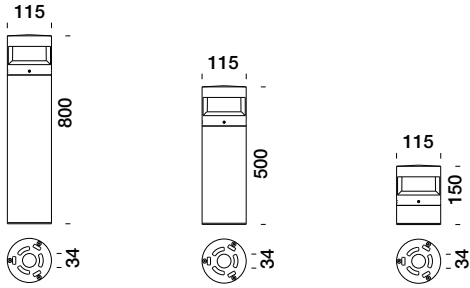

MICRO MENHIR bollard H. 150 mm

COB LED white - 220-240V 50/60Hz

TRIAC dimmable

LED Data= 3000K (900 lm) - 4000K (936 lm)

40 11 111	●	11W	3000K (220 lm)	1 opening
40 11 112	●	11W	3000K (440 lm)	2 openings
40 11 161	○	11W	4000K (230 lm)	1 opening
40 11 162	○	11W	4000K (460 lm)	2 openings

MICRO MENHIR bollard H. 500 mm

COB LED white - 220-240V 50/60Hz

TRIAC dimmable

LED Data= 3000K (1350 lm) - 4000K (1404 lm)

40 11 211	●	15,5W	3000K (330 lm)	1 opening
40 11 212	●	15,5W	3000K (665 lm)	2 openings
40 11 261	○	15,5W	4000K (345 lm)	1 opening
40 11 262	○	15,5W	4000K (690 lm)	2 openings

MICRO MENHIR bollard H. 800 mm

COB LED white - 220-240V 50/60Hz

TRIAC dimmable

LED Data= 3000K (1350 lm) - 4000K (1404 lm)

40 11 311	●	15,5W	3000K (330 lm)	1 opening
40 11 312	●	15,5W	3000K (665 lm)	2 openings
40 11 361	○	15,5W	4000K (345 lm)	1 opening
40 11 362	○	15,5W	4000K (690 lm)	2 openings

ACCESSORIES

89 17 004	●	IP68 IN/OUT connector for 3x4 mm ² cable
89 50 030	●	Tie-rod

MENHIR bollard design by Lundbergdesign



IP65, IK 08

platek.eu/MENHIR

available colours

.06 grey; .08 anthracite
other colours available on request with
no price increase
.01 black; .02 white;
.07 corten; .09 bronze

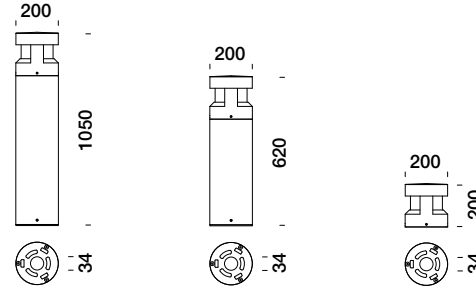

MENHIR bollard H. 200 mm

COB LED white - 220-240V 50/60Hz

LED Data= 3000K (1740 lm) - 4000K (1810 lm)

40 32 611	○	15,5W	3000K (510 lm)	1 opening
40 32 612	○	15,5W	3000K (915 lm)	2 openings
40 32 661	○	15,5W	4000K (530 lm)	1 opening
40 32 662	○	15,5W	4000K (950 lm)	2 openings

MENHIR bollard H. 620 mm

COB LED white - 220-240V 50/60Hz

LED Data= 3000K (2400 lm) - 4000K (2496 lm)

40 52 611	○	20W	3000K (775 lm)	1 opening
40 52 612	○	20W	3000K (1240 lm)	2 openings
40 52 661	○	20W	4000K (805 lm)	1 opening
40 52 662	○	20W	4000K (1290 lm)	2 openings

MENHIR bollard H. 1050 mm

COB LED white - 220-240V 50/60Hz

LED Data= 3000K (4355 lm) - 4000K (4529 lm)

40 82 611	○	40W	3000K (1430 lm)	1 opening
40 82 612	○	40W	3000K (2500 lm)	2 openings
40 82 661	○	40W	4000K (1500 lm)	1 opening
40 82 662	○	40W	4000K (2600 lm)	2 openings

ACCESSORIES

89 50 003	●	Tie-rod - MENHIR H. 200
89 50 001	●	Tie-rod - MENHIR H. 620 / 1050 mm

TRIS

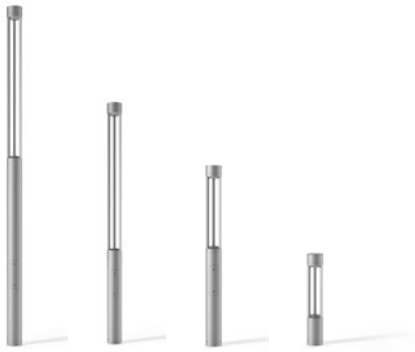

IP66, IK 10

platek.eu/TRIS

available colours

.06 grey

other colours available on request with no price increase

.01 black; .02 white; .07 corten;

.08 anthracite; .09 bronze

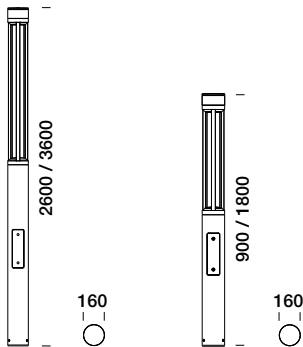

TRIS H. 900 mm

COB LED white - 220-240V 50/60Hz

LED Data= 3000K (2600 lm) - 4000K (2704 lm)

33 33 611	●	21W	3000K (2150 lm)
33 33 661	○	21W	4000K (2240 lm)

TRIS H. 1800 mm

COB LED white - 220-240V 50/60Hz

LED Data= 3000K (3685 lm) - 4000K (3832 lm)

33 33 612	○	30W	3000K (3200 lm)
33 33 662	○	30W	4000K (3330 lm)

TRIS H. 2600 mm

COB LED white - 220-240V 50/60Hz

LED Data= 3000K (4900 lm) - 4000K (5145 lm)

33 33 614	○	45W	3000K (4515 lm)
33 33 664	○	45W	4000K (4700 lm)

TRIS H. 3600 mm

COB LED white - 220-240V 50/60Hz

LED Data= 3000K (4900 lm) - 4000K (5145 lm)

33 33 613	○	45W	3000K (4515 lm)
33 33 663	○	45W	4000K (4700 lm)

ACCESSORIES

89 50 080	●	Recessed housing
89 50 075	●	Tie-rod
89 01 045	●	Shield for two openings

● Product available in stock

○ Product available on request

TUBE



IP65, IK 10

platek.eu/TUBE

other colours available on request with no price increase

.01 black; .02 white; .06 grey

.07 corten; .08 anthracite; .09 bronze

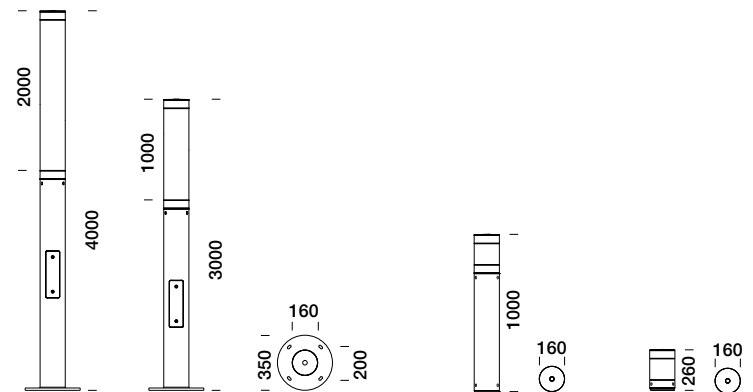

TUBE H. 260 mm - LED white - 220-240V 0/50/60Hz LED Data= 3000K (1000 lm) - 4000K (1040 lm)

33 65 610	○	10W	3000K (415 lm)	Transparent
33 66 610	○	10W	3000K (605 lm)	Sandblasted
33 65 660	○	10W	4000K (920 lm)	Transparent
33 66 660	○	10W	4000K (1250 lm)	Sandblasted

TUBE H. 1000 mm - LED white - 220-240V 0/50/60Hz

LED Data= 3000K (2000 lm) - 4000K (2080 lm)

33 65 611	○	20W	3000K (920 lm)	Transparent
33 66 611	○	20W	3000K (1250 lm)	Sandblasted
33 65 661	○	20W	4000K (961 lm)	Transparent
33 66 661	○	20W	4000K (1300 lm)	Sandblasted

TUBE H. 3000 / 4000 mm - LED white - 220-240V 50/60Hz

LED Data= 3000K (4512 lm) - 4000K (4692 lm)

33 65 613	○	42W	3000K (2015 lm)	Transparent	H. 3000 mm
33 66 613	○	42W	3000K (2835 lm)	Sandblasted	H. 3000 mm
33 65 663	○	42W	4000K (2096 lm)	Transparent	H. 3000 mm
33 66 663	○	42W	4000K (2949 lm)	Sandblasted	H. 3000 mm
33 65 614	○	42W	3000K (2015 lm)	Transparent	H. 4000 mm
33 66 614	○	42W	3000K (2835 lm)	Sandblasted	H. 4000 mm
33 65 664	○	42W	4000K (2096 lm)	Transparent	H. 4000 mm
33 66 664	○	42W	4000K (2949 lm)	Sandblasted	H. 4000 mm

TUBE H. 260 / 1000 / 3000 / 4000 mm - LED RGBW - 500mA -

33 66 600	○	11,5W	RGBW	Sandblasted	H. 260 mm
33 66 601	○	16,5W	RGBW	Sandblasted	H. 1000 mm
33 66 603	○	35W	RGBW	Sandblasted	H. 3000 mm
33 66 604	○	35W	RGBW	Sandblasted	H. 4000 mm

ACCESSORIES

89 50 035	●	Tie-rod for bollard TUBE 260
89 50 075	●	Tie-rod for bollard TUBE 1000
89 50 080	●	Recessed housing TUBE 1000
89 50 090	●	Tie-rod for bollard TUBE 3000 / 4000

RGBW Control systems for dynamic light on page 102

● Product available on request until the end of stocks

T4



IP65, IK 10

platek.eu/T4

other colours available on request with no price increase

.01 black; .02 white; .06 grey
.07 corten; .08 anthracite; .09 bronze

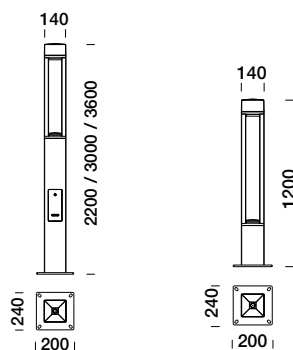

T4 bollard H. 1200 mm

COB LED white - 220-240V 50/60Hz

LED Data= 3000K (2600 lm) - 4000K (2704 lm)

50 34 611	<input type="radio"/>	21W	3000K (1830 lm)
50 34 661	<input type="radio"/>	21W	4000K (1900 lm)

T4 bollard H. 2200 mm

COB LED white - 220-240V 50/60Hz

LED Data= 3000K (3685 lm) - 4000K (3832 lm)

50 34 612	<input type="radio"/>	30W	3000K (2600 lm)
50 34 662	<input type="radio"/>	30W	4000K (2700 lm)

T4 bollard H. 3000 mm

COB LED white - 220-240V 50/60Hz

LED Data= 3000K (4900 lm) - 4000K (5145 lm)

50 34 613	<input type="radio"/>	45W	3000K (3960 lm)
50 34 663	<input type="radio"/>	45W	4000K (4120 lm)

T4 bollard H. 3600 mm

COB LED white - 220-240V 50/60Hz

LED Data= 3000K (4900 lm) - 4000K (5145 lm)

50 34 614	<input type="radio"/>	45W	3000K (3960 lm)
50 34 664	<input type="radio"/>	45W	4000K (4120 lm)

ACCESSORIES

89 50 090	<input checked="" type="radio"/>	Tie-rod
-----------	----------------------------------	---------

TETRA PARCO



IP65, IK 10

platek.eu/TETRAPARCO

other colours available on request with no price increase

.01 black; .02 white; .06 grey
.07 corten; .08 anthracite; .09 bronze

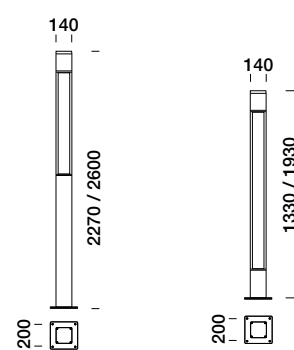

TETRA PARCO H. 1330 mm

COB LED white - 220-240V 0/50/60Hz

LED Data= 3000K (3685 lm) - 4000K (3832 lm)

50 35 611	<input type="radio"/>	26W	3000K (1100 lm)
50 35 661	<input type="radio"/>	26W	4000K (1145 lm)

TETRA PARCO H. 1930 mm

COB LED white - 220-240V 0/50/60Hz

LED Data= 3000K (3685 lm) - 4000K (3832 lm)

50 35 612	<input type="radio"/>	26W	3000K (1100 lm)
50 35 662	<input type="radio"/>	26W	4000K (1145 lm)

TETRA PARCO H. 2270 mm

COB LED white - 220-240V 0/50/60Hz

LED Data= 3000K (4900 lm) - 4000K (5145 lm)

50 35 613	<input type="radio"/>	38W	3000K (1460 lm)
50 35 663	<input type="radio"/>	38W	4000K (1535 lm)

TETRA PARCO H. 2600 mm

COB LED white - 220-240V 0/50/60Hz

LED Data= 3000K (4900 lm) - 4000K (5145 lm)

50 35 614	<input type="radio"/>	38W	3000K (1460 lm)
50 35 664	<input type="radio"/>	38W	4000K (1535 lm)

ACCESSORIES

89 50 090	<input checked="" type="radio"/>	Tie-rod
-----------	----------------------------------	---------

TARSIUS pole mounted design by Piero Castiglioni



IP66, IK 10

platek.eu/TARSIUS

available colours

.06 grey

other colours available on request with no price increase

.01 black; .02 white;

.07 corten; .08 anthracite; .09 bronze

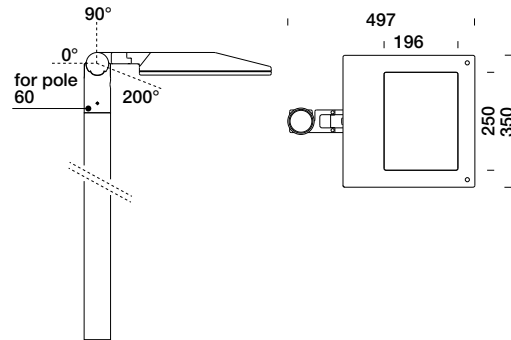

LED white - 220-240V 0/50/60Hz

Integral DALI driver

LED Data= 3000K (6000 lm) - 4000K (6240 lm)

87 50 918	●	58W	3000K (5110 lm)	Street
87 50 919	●	58W	3000K (4585 lm)	Asymmetric
87 50 968	○	58W	4000K (5320 lm)	Street
87 50 969	○	58W	4000K (4765 lm)	Asymmetric

LED white - 220-240V 0/50/60Hz

Midnight

LED Data= 3000K (5088 lm) - 4000K (5292 lm)

87 50 718	○	51W	3000K (4245 lm)	Street
87 50 719	○	51W	3000K (4245 lm)	Asymmetric
87 50 768	○	51W	4000K (4415 lm)	Street
87 50 769	○	51W	4000K (4415 lm)	Asymmetric

ACCESSORIES

86 50 020	●	Ø 60 mm pole adaptor for two light fittings
86 50 025	●	Ø 76 mm pole adaptor for single light fittings
86 50 004	○	H. 4 m pole (Ø 60 mm connection) 0,5 m ground recessed
86 50 006	○	H. 6 m pole (Ø 60 mm connection) 0,8 m ground recessed
86 50 008	○	H. 8 m pole (Ø 60 mm connection) 0,8 m ground recessed

● Product available in stock

○ Product available on request

MONACO pole mounted



IP65, IK 10

platek.eu/MONACO

other colours available on request with no price increase

.01 black; .02 white; .06 grey

.07 corten; .08 anthracite; .09 bronze

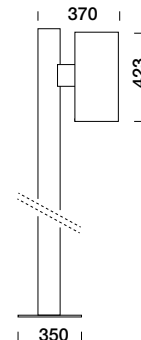

4 LED white - 220-240V 0/50/60Hz

LED Data= 3000K (4320 lm) - 4000K (4493 lm)

87 55 719	○	36W	3000K (3250 lm)	Street
87 55 769	○	36W	4000K (3380 lm)	Street

ACCESSORIES

89 18 650	●	Elliptical filter
89 18 655	●	Sandblasted filter
89 18 659	●	Extensive filter
86 23 061	○	Pole with base plate (200x200 mm holes wheelbase), suitable for 1 luminaire, H 4 m
86 23 062	○	Pole with base plate (200x200 mm holes wheelbase), suitable for 2 luminaires, H 4 m

○ Product available on request until the end of stocks

BALI pole mounted



IP65, IK 10

platek.eu/TETRAPARCO

other colours available on request with no price increase

.01 black; .02 white; .06 grey
.07 corten; .08 anthracite; .09 bronze

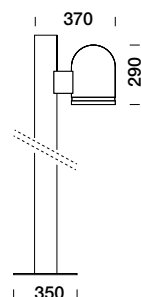

COB LED white - 220-240V 50/60Hz \oplus

LED Data= 3000K (3200 lm) - 4000K (3328 lm)

87 12 616	\bullet	27W	3000K (2560 lm)	38°
87 12 666	\bullet	27W	4000K (2660 lm)	38°

4 LED white - 220-240V 0/50/60Hz \oplus

LED Data= 3000K (4320 lm) - 4000K (4493 lm)

87 12 719	\bullet	36W	3000K (3200 lm)	Street
87 12 769	\bullet	36W	4000K (3330 lm)	Street

ACCESSORIES

89 18 650	\bullet	Elliptical filter
89 18 655	\bullet	Sandblasted filter
89 18 659	\bullet	Extensive filter
86 23 061	\circ	Pole with base plate (200x200 mm holes wheelbase), suitable for 1 luminaire, H 4 m
86 23 062	\circ	Pole with base plate (200x200 mm holes wheelbase), suitable for 2 luminaires, H 4 m

\bullet Product available in stock

\circ Product available on request

\bullet Product available on request until the end of stocks

SERVICE POST



IP65 (closed)
IP20 (open)
IK 06

available colours
.08 anthracite

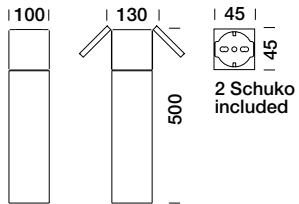

SERVICE POST

Complete with 2 European schuko sockets

16A / 250V ⊕

1 m cable length (3x1 mm²)

H. 500 mm

89 10 502

ACCESSORIES

89 50 045 ● Tie-rod
90 05 190 ● Spike

Indoor
technical li

96 – 99

ghting

E2 plus design by Mamadesign

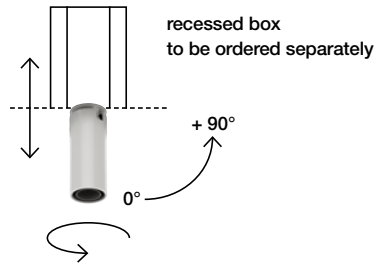

IP20

available colours
.26 black; .27 white

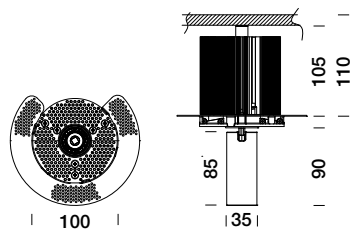

LED white - 250mA

(power supply and recessed box to be ordered separately)
LED Data= 2700K / 3000K (719 lm)

94 20 093	○	7W	2700K (330 lm)	23°
94 20 098	○	7W	2700K (510 lm)	39°
94 20 013	●	7W	3000K (330 lm)	23°
94 20 018	●	7W	3000K (510 lm)	39°

Notes

Inspectionable product.
Possibility of recessed, semi-recessed or external/ adjustable use.
Possibility to add the SLIM driver through the luminaire hole.
On/off non-dimmable driver.

Video of operational installation



ACCESSORIES

94 20 900	●	Recessed box E2 PLUS - drywalls
89 56 036	●	IP20 slim (250mA - 10W) driver for 1 product. Slim driver can be inserted and extracted from the hole of the luminaire.
89 56 116	●	Dimmable driver for maximum 3 luminaires (250mA) (250/350mA - 30/40W) IP20 1-10V+Push+DALI

E4 plus design by Mamadesign

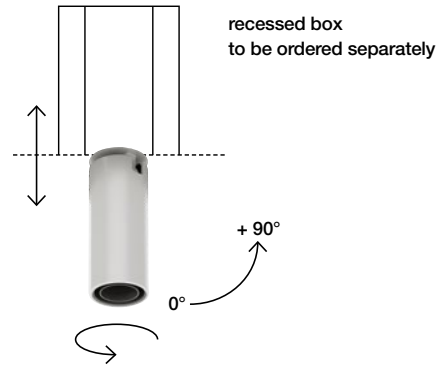

IP20

available colours
.26 black; .27 white

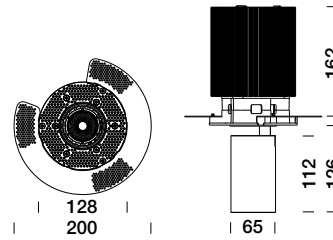

LED white - 500mA

(power supply and recessed box to be ordered separately)
LED Data= 2700K / 3000K (1776 lm)

94 20 293	○	17W	2700K (650 lm)	23°
94 20 298	○	17W	2700K (1130 lm)	47°
94 20 213	●	17W	3000K (650 lm)	23°
94 20 218	●	17W	3000K (1130 lm)	47°

Notes

Inspectionable product.
Possibility of recessed, semi-recessed or external/ adjustable use.
Possibility to add the SLIM driver through the luminaire hole.
On/off non-dimmable driver.

Video of operational installation



ACCESSORIES

94 20 920	●	Recessed box E4 PLUS - drywalls
89 56 219	●	IP20 Slim (500mA - 20W) driver for 1 product. Slim driver can be inserted and extracted from the hole of the luminaire.
89 56 116	●	Dimmable driver for maximum 2 luminaires (500mA) (500mA - 50W) IP20 1-10V+Push+DALI

E2 plaster / reinforced concrete design by Mamadesign

Recessed box for plaster

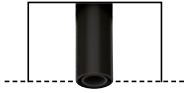

Recessed box for reinforced concrete

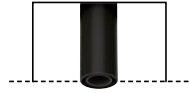

Recessed box for drywalls



IP20 / IP44

available colours

.26 black;
other colours available on request with
no price increase
.27 white

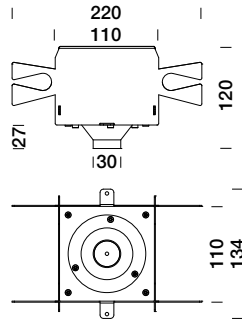
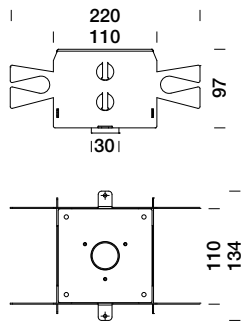

IP20 / IP44

available colours

.26 black;
other colours available on request with
no price increase
.27 white

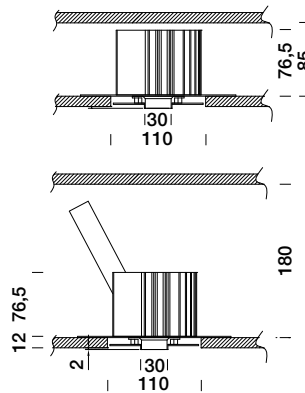

E2 - IP20

LED white - 350mA

(power supply and recessed box to be ordered separately)

LED Data= 2700K / 3000K (1070 lm)

94 03 093	○	10W	2700K (340 lm)	23°
94 03 095	○	10W	2700K (400 lm)	45°
94 03 013	○	10W	3000K (370 lm)	23°
94 03 015	○	10W	3000K (433 lm)	45°

E2 - IP44

LED white - 350mA

(power supply and recessed box to be ordered separately)

LED Data= 2700K / 3000K (1070 lm)

94 03 093 IP	○	10W	2700K (340 lm)	23°
94 03 095 IP	○	10W	2700K (400 lm)	45°
94 03 013 IP	○	10W	3000K (370 lm)	23°
94 03 015 IP	○	10W	3000K (433 lm)	45°

Notes

Inspectionable product.
Remote driver.

E2 - IP20

LED white - 350mA

(power supply and recessed box to be ordered separately)

LED Data= 2700K / 3000K (1070 lm)

94 03 093	○	10W	2700K (340 lm)	23°
94 03 095	○	10W	2700K (400 lm)	45°
94 03 013	○	10W	3000K (370 lm)	23°
94 03 015	○	10W	3000K (433 lm)	45°

E2 - IP44

LED white - 350mA

(power supply and recessed box to be ordered separately)

LED Data= 2700K / 3000K (1070 lm)

94 03 093 IP	○	10W	2700K (340 lm)	23°
94 03 095 IP	○	10W	2700K (400 lm)	45°
94 03 013 IP	○	10W	3000K (370 lm)	23°
94 03 015 IP	○	10W	3000K (433 lm)	45°

Notes

Inspectionable product.
Remote driver.

ACCESSORIES

89 45 105	●	Recessed box E2 - plaster
89 45 110	●	Recessed box E2 - reinforced concrete
89 56 215	●	IP20 Power supply (max. 350mA - 15W) for 1 product
89 56 116	●	Dimmable driver for maximum 3 luminaires (250mA) (250/350mA - 30/40W) IP20 1-10V+Push+DALI

ACCESSORIES

89 45 115	●	Recessed box E2 - drywalls
89 56 215	●	IP20 Power supply (max. 350mA - 15W) for 1 product
89 56 116	●	Dimmable driver for maximum 3 luminaires (250mA) (250/350mA - 30/40W) IP20 1-10V+Push+DALI
89 56 039	●	IP20 SLIM driver with bracket (350mA) for 1 luminaire. Slim driver can be inserted and extracted from the hole of the luminaire.

M'ATTACCO 1.0



IP20

other colours available on request with no price increase
.26 black; .27 white

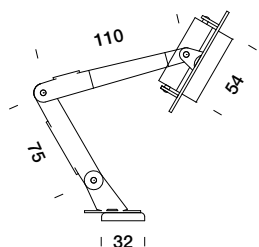

M'ATTACCO 1.0

LED white - 24V DC

(power supply to be ordered separately)

LED Data= 3000K (565 lm)

94 10 111	○	5W	3000K (466 lm)	12°
94 10 113	○	5W	3000K (437 lm)	33°
94 10 118	○	5W	3000K (444 lm)	44°

M'ATTACCO 1.0

LAMP - 250V -

(lamp to be ordered separately)

94 10 030	○	50W	GZ10
-----------	---	-----	------

Notes

Product with adjustable arm and head by magnetic fixing

ACCESSORIES

89 56 104	●	IP20 Power supply (24V DC - 30W)
89 56 307	●	IP20 Power supply (24V DC - 75W)
89 56 172	●	IP67 Power supply (24V DC - 30W)
89 56 127	●	IP67 Power supply (24V DC - 75W)
89 56 074	●	IP67 Power supply (24V DC - 150W)

● Product available in stock

○ Product available on request

M'ATTACCO 2.0



IP20

other colours available on request with no price increase
.26 black; .27 white

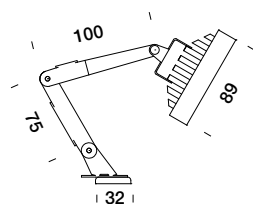

M'ATTACCO 2.0

LED white - 24V DC

(power supply to be ordered separately)

LED Data= 3000K (1128 lm)

94 11 211	○	10W	3000K (958 lm)	9°
94 11 213	○	10W	3000K (858 lm)	28°
94 11 218	○	10W	3000K (775 lm)	44°

Notes

Product with adjustable arm and head by magnetic fixing

ACCESSORIES

89 56 104	●	IP20 Power supply (24V DC - 30W)
89 56 307	●	IP20 Power supply (24V DC - 75W)
89 56 172	●	IP67 Power supply (24V DC - 30W)
89 56 127	●	IP67 Power supply (24V DC - 75W)
89 56 074	●	IP67 Power supply (24V DC - 150W)

● Product available on request until the end of stocks

M'ATTACCO 3.0



IP20

other colours available on request with
no price increase
.26 black; .27 white

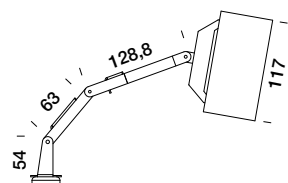

M'ATTACCO 3.0

LAMP - 250V

(lamp to be ordered separately)

94 12 000 100W QR111

Notes

Product with adjustable arm and head by magnetic fixing

Accessorie

102 — 133

S

REGO 24 LED driver



REGO 24 control diagram

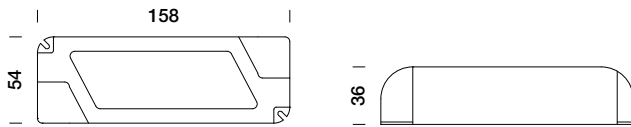
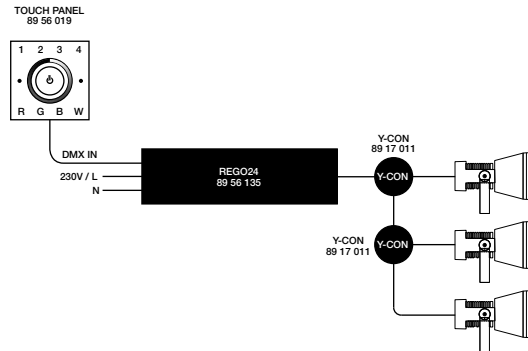

REGO 24 CONTROLLER LED - 220-240V 50/60Hz

- 89 56 135 ● 4 Channels (max. 6 LED/channel) 220-240V 50/60Hz max. 40W OUT 500mA

REGO 48 LED driver



DMX 512 power and control diagram for REGO 48

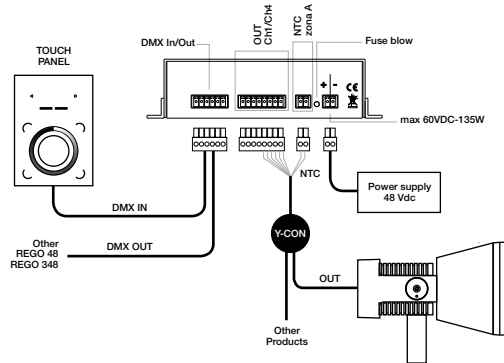

Ethernet and/or WIFI operating diagram for REGO 48

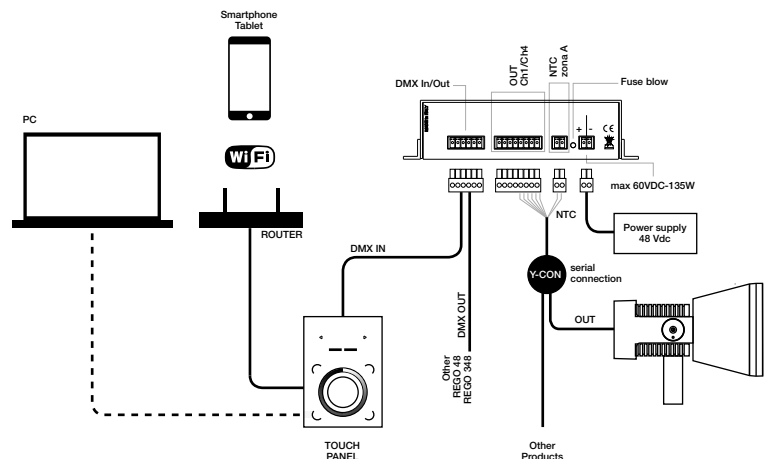

REGO 48 CONTROLLER LED

- 89 56 110 ● 4 DMX-RDM Channels (max. 12 LEDs) channel IN max 60V-135W OUT 350/500/700mA

ACCESSORI

- 89 17 011 ● Y-CON connector with box to be resin-coated
- 89 56 063 ● Two-component resin (max. 2 Y-CON connectors)
- 89 56 019 ● Touch Panel Lite (4 CH. RGBW 100-240V)
- 89 56 119 ● Touch panel control RGBW 1024 channels USB/ethernet
- 89 56 157 ● 30 m cable length (10x0,32 mm²) for RGBW connections and dynamic light
- 89 56 158 ● 60 m cable length (10x0,32 mm²) for RGBW connections and dynamic light
- 89 56 151 ● Cable DMX length 1 m.
- 89 56 154 ● Cable DMX length 0,4 m.

ACCESSOIRES

- 89 56 019 ● Touch panel lite (4 CH. RGBW 100-240V)
- 89 56 119 ● Touch panel control RGBW 1024 ch USB/ethernet
- 89 56 151 ● Cable DMX length 1 m.
- 89 56 154 ● Cable DMX length 0,4 m.
- 89 56 063 ● Two-component resin (max. 2 Y-CON connectors)
- 89 56 120 ● IP20 Power supply (48V DC - 75W)
- 89 56 121 ● IP20 Power supply (48V DC - 120W)
- 89 17 011 ● Y-CON connector with box to be resin-coated
- 89 56 157 ● 30 m cable length (10x0,32 mm²) for RGBW connections and dynamic light
- 89 56 158 ● 60 m cable length (10x0,32 mm²) for RGBW connections and dynamic light

REGO 384 LED driver



DMX 512 power and control diagram for REGO 384

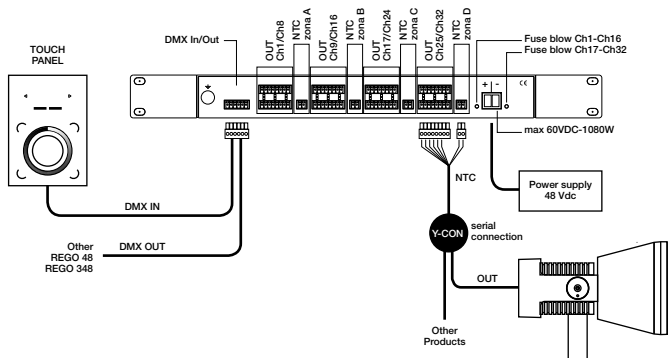

Ethernet and/or WIFI operating diagram for REGO 384

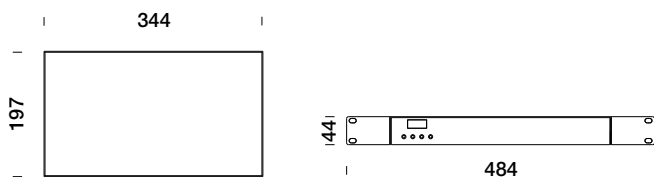
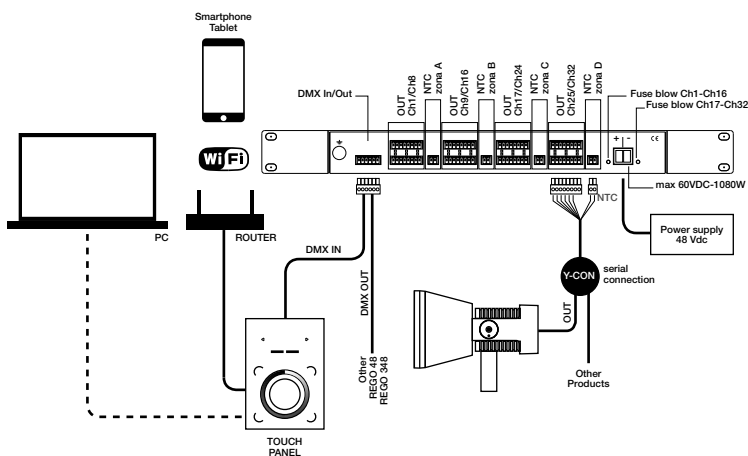

REGO 384 CONTROLLER LED

- 89 56 115 ● 32 DMX-RDM channels (max. 12 LEDs/channel)
IN max. 60V-1080W OUT 350/500/700mA

ACCESSOIRES

- 89 56 019 ● Touch panel lite (4 CH. RGBW 100-240V)
- 89 56 119 ● Touch panel control RGBW 1024 ch USB/ethernet
- 89 56 151 ● Cable DMX length 1 m.
- 89 56 154 ● Cable DMX length 0,4 m.
- 89 56 063 ● Two-component resin (max. 2 Y-CON connectors)
- 89 56 122 ● IP20 Power supply (48V DC - 480W)
- 89 56 123 ● IP20 Power supply (48V DC - 960W)
- 89 17 011 ● Y-CON connector with box to be resin-coated
- 89 56 157 ● 30 m cable length (10x0,32 mm²)
for RGBW connections and dynamic light
- 89 56 158 ● 60 m cable length (10x0,32 mm²)
for RGBW connections and dynamic light

Control systems for dynamic light - RGBW





PRODUCT NAME / CODE	REGO 24 / 89 56 135	REGO 48 / 89 56 110	REGO 384 / 89 56 115
LED quantity	max 24 LEDs - 4 Channels max 6 LEDs/Channel	max 48 LEDs - 4 Channels max 12 LEDs/Channel	max 384 LEDs - 32 Channels max 12 LEDs/Channel
INPUT	220-240V 50/60Hz (direct power supply)	24-60V DC (to be ordered separately)	24-60V DC (to be ordered separately)
OUTPUT	500mA, in serial connection	350/500/700mA, in serial connection	350/500/700mA, in serial connection
Control	LED 4 channels dynamic light (RGB+W), separately programmable	LED 4 channels dynamic light (RGB+W), separately programmable	LED 4 channels dynamic light (RGB+W), separately programmable
Preset scenarios	18 preset light shows - 13 fixed colours and - 5 dynamic colours	4 preset light shows with possibility to change speed and mode	4 preset light shows with possibility to change speed and mode
Setting	/	DMX 512 - RDM	DMX 512 - RDM
Power supply/LED connection distance	max. 100 m by 1 mm ² cable	max. 250 m by 1,5 mm ² cable	max. 250 m by 1,5 mm ² cable
Parameters monitoring	/	external display / external interface	external display / external interface
Control options	key functions Touch Panel 89 56 119 Touch Panel Lite 89 56 019 advanced control system with Smartphone/Tablet	display for "stand-alone" mode Touch Panel 89 56 119 Touch Panel Lite 89 56 019 advanced control system with Smartphone/Tablet	display for "stand-alone" mode Touch Panel 89 56 119 Touch Panel Lite 89 56 019 advanced control system with Smartphone/Tablet

NAME	CODE	IMAGE
Two-part resin (max. 2 Y-CON connectors)	89 56 063	

NAME	CODE	IMAGE
30 m cable (10 x 0,32 mm ²) for RGBW connections and dynamic light	89 56 157	

NAME	CODE	IMAGE
DMX cable, 1 m length	89 56 151	

NAME	CODE	IMAGE
60 m cable (10 x 0,32 mm ²) for RGBW connections and dynamic light	89 56 158	

NAME	CODE	IMAGE
DMX cable, 0,4 m length	89 56 154	

Battery charger IP20



PRODUCT CODE 89 56 014

Protection rating	IP20
Voltage range input	100~240V 50/60Hz 0.35A
Voltage output	5V 2000mA

Power supply units



PRODUCT CODE 89 56 120

Rated power	75W
Protection rating	IP20
Voltage range input	85~240V AC – 120~370V DC
Voltage output	48V DC
Dimmable	No
Cable length	/
Dimensions (LxWxH)	100x56x126 (DIN RAIL)



PRODUCT CODE 89 56 121

Rated power	120W
Protection rating	IP20
Voltage range input	90~264V AC – 127~370V DC
Voltage output	48V DC
Dimmable	No
Cable length	/
Dimensions (LxWxH)	114x40x126 (DIN RAIL)



PRODUCT CODE 89 56 122

Rated power	480W
Protection rating	IP20
Voltage range input	90~264V AC – 127~370V DC
Voltage output	48V DC
Dimmable	No
Cable length	/
Dimensions (LxWxH)	129x86x126 (DIN RAIL)



PRODUCT CODE 89 56 123

Rated power	960W
Protection rating	IP20
Voltage range input	180~264V AC – 274~370V DC
Voltage output	48V DC
Dimmable	No
Cable length	/
Dimensions (LxWxH)	110x126x156

Controllers



PRODUCT CODE 89 17 011

Wires (mm ²)	max 10x1,5 (x3)
Number of poles per wire	max 10
Max poles size (mm ²)	1,5 mm ²
Connection type	Screw
Connection mode	/
Protection grade	IP44
Electric specs.	/



PRODUCT CODE 89 56 019

Wires (mm ²)	/
Number of poles per wire	/
Max poles size (mm ²)	1,5 mm ²
Connection type	DMX
Connection mode	/
Protection grade	/
Electric specs.	100~240V AC



PRODUCT CODE 89 56 119

Wires (mm ²)	/
Number of poles per wire	/
Max poles size (mm ²)	1,5 mm ²
Connection type	DMX + Ethernet
Connection mode	Screw
Protection grade	/
Electric specs.	6V DC (power supply included)

24V DC power supply units IP20

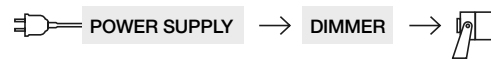

PRODUCT CODE	89 56 104	89 56 307	89 56 300
Rated output	30W	75W	12A
Protection rating	IP20	IP20	IP20
Voltage range input	220~240V 0/50/60 Hz	100~240V 50/60 Hz	24V
Voltage output	24V DC	24V DC	24V DC
Dimmable	No	No	DALI, push, 1~10V, 0~10V / Slave
Cable length	/	/	/
Dimensions (LxWxH)	125x38x23 mm	183x61x29 mm	156x52x26 mm

24V DC power supply units IP67



PRODUCT CODE	89 56 172	89 56 127	89 56 074
Rated power	30W	75W	150W
Protection rating	IP67	IP67	IP67
Voltage range input	220~240V 50/60 Hz	220~240V 50/60 Hz	220~240V 50/60 Hz
Voltage output	24V DC	24V DC	24V DC
Dimmable	No	No	No
Cable length	335 mm	335 mm	335 mm
Dimensions (LxWxH)	131x42x34 mm	155x49x33 mm	206x69x37 mm



PRODUCT CODE	89 56 308	89 56 312	89 56 324
Rated power	80W	120W	240W
Protection rating	IP67	IP67	IP67
Voltage range input	220~240V 50/60 Hz	220~240V 50/60 Hz	220~240V 50/60 Hz
Voltage output	24V DC	24V DC	24V DC
Dimmable	1~10V	1~10V	1~10V
Cable length	300 mm	300 mm	300 mm
Dimensions (LxWxH)	250x30x34	250x60x39	250x80x39

12V DC power supply units IP20



PRODUCT CODE 89 56 109

Rated power	18W
Protection rating	IP20
Voltage range input	220~240V
Voltage output	12V DC
Dimmable	No
Cable length	/
Dimensions (LxWxH)	125x38x23

12V DC power supply units IP67



PRODUCT CODE 89 56 091

89 56 114

89 56 103

Rated power	14W	25W	60W
Protection rating	IP67	IP67	IP67
Voltage range input	220~240V	90~295V	100~305V
Voltage output	12V DC	12V DC	12V DC
Dimmable	No	No	No
Cable length	190 mm	300 mm	300 mm
Dimensions (LxWxH)	85x39x19	148x40x32	180x63x36

Constant current power supply units (☺ on request) IP67



PRODUCT CODE 89 56 069

89 56 059

89 56 054

Rated power	6W	15W	6W
Protection rating	IP67	IP67	IP67
Voltage range input	220~240V AC 0~50~60 Hz	220~240V AC 50~60 Hz	220~240V AC 50~60 Hz
Current output	350 mA	350 mA	500 mA
Dimmable	No	No	No
Cable length	200 mm	500 mm	200 mm
Dimensions (LxWxH)	60x45x25 mm	120x40x31 mm	60x45x25 mm



PRODUCT CODE 89 56 047

89 56 090

89 56 117

Rated power	15W	14W	30W
Protection rating	IP67	IP67	IP67
Voltage range input	220~240V AC 50~60 Hz	220~240V AC 0~50~60 Hz	220~240V AC 50~60 Hz
Current output	500 mA	700 mA	700 mA
Dimmable	No	No	No
Cable length	500 mm	190 mm	500 mm
Dimensions (LxWxH)	120x40x31 mm	85x39x19 mm	150x40x31 mm

Constant current power supply units IP20



PRODUCT CODE 89 56 036

Rated output	10W
Protection rating	IP20
Voltage range input	220~240V 0/50/60 Hz
Current output	250 mA
Dimmable	/
Cable length	/
Dimensions (LxWxH)	132x22x18



PRODUCT CODE 89 56 116

Rated output	30W (250mA) 40W (350mA)
Protection rating	IP20
Voltage range input	220~240V 0/50/60 Hz
Current output	250 mA - 350 mA
Dimmable	DALI, 1~10V, Push
Cable length	/
Dimensions (LxWxH)	124x79x22



PRODUCT CODE 89 56 219

Rated output	20W
Protection rating	IP20
Voltage range input	110~240V 0/50/60 Hz
Current output	500 mA
Dimmable	/
Cable length	/
Dimensions (LxWxH)	130x38x28



PRODUCT CODE 89 56 215

Rated power	15W
Protection rating	IP20
Voltage range input	220~240V 0/50/60 Hz
Current output	350 mA
Dimmable	/
Cable length	/
Dimensions (LxWxH)	125x38x23

Connectors

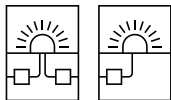

PRODUCT CODE

89 17 004

89 17 012

89 17 013

Maximum cable outside diameter	6,5-12	4,5-8,5	4,5-8,5
Number of pole per wire	3	4	2
Max poles size (mm ²)	4	1,5	1,5
Connection type	Through wiring	Through wiring	Through wiring
Connection mode	For parallel connection	For parallel connection	For serial connection
Protection rating	IP68	IP68	IP68
Electric specs.	250V/16A	450V/25A	450V/25A

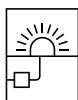

PRODUCT CODE

89 17 006

89 17 014







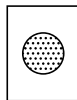



89 17 021

Maximum cable outside diameter	4,6-6	7-12	6,5-12
Number of pole per wire	2	3	3
Max poles size (mm ²)	0,75	1,5	2,5
Connection type	In line	In line	Through wiring
Connection mode	/	/	For serial connection
Protection rating	IP68	IP68	IP68
Electric specs.	250V/16A	450V/32A	250V/16A

Filters











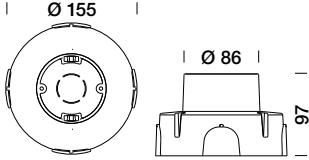

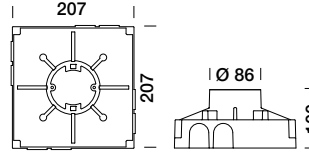

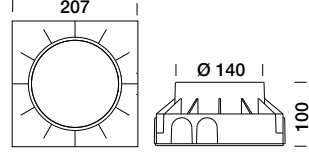
RELATED PRODUCT	CODE	IMAGE	RELATED PRODUCT	CODE	IMAGE
FROG	89 05 060 Shield visor		MICRO STEEL	89 18 015 Sandblasted filter	
FROG	89 05 065 Honeycomb filter (in colour .01 .02)		MICRO SPRING floodlight SPOT 100	89 18 780 Elliptical filter	
FROG	89 05 066 Honeycomb filter (to be used in addition to filters/visors)			89 18 785 Sandblasted filter	
FROG	89 18 055 Elliptical filter (in colour .01 .02)			89 18 787 Antiglare deflector	
FROG	89 18 057 Extensive filter (in colour .01 .02)			89 18 786 Honeycomb grid	
FROG	89 18 058 Visor with extensive filter		MINI SPRING floodlight	89 18 670 Elliptical filter	
FROG	89 18 059 Visor with elliptical filter			89 18 675 Sandblasted filter	

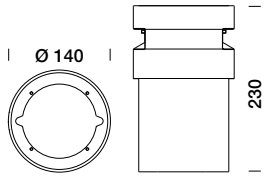

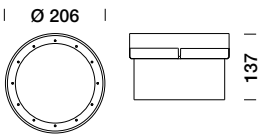

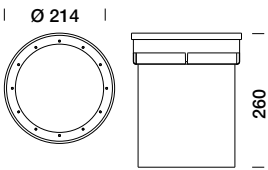

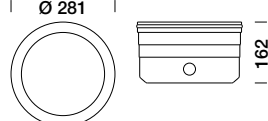



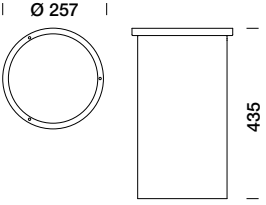

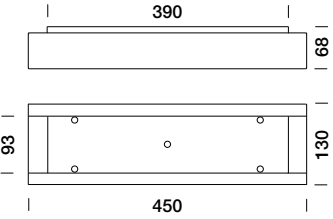
RELATED PRODUCT	CODE	IMAGE	RELATED PRODUCT	CODE	IMAGE
MINI full inox drive over MINI drive over MINI floodlight MINI ceiling recessed	89 18 750 Elliptical filter		MONACO pole mounted BALI pole mounted	89 18 659 Extensive filter	
	89 18 755 Sandblasted filter		MEDIO	89 18 610 Anti-slip glass	
SPRING floodlight SPOT 200	89 18 660 Elliptical filter		MEDIO stainless steel ring	89 18 615 Anti-slip glass	
	89 18 665 Sandblasted filter				
MEDIO drive over MONACO 200 SPOT downlight STEEL 200 underwater floodlight	89 18 650 Elliptical filter				
	89 18 655 Sandblasted filter				
ATLANTIQUE drive over ATLANTIQUE floodlight	89 18 205 Sandblasted filter				

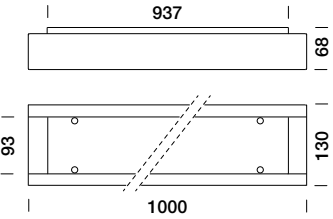

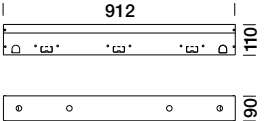

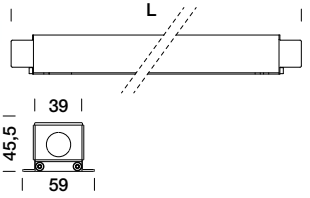

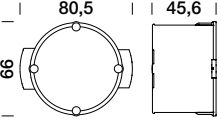

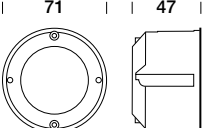

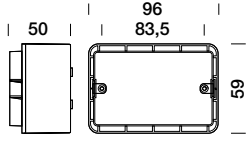
Recessed boxes

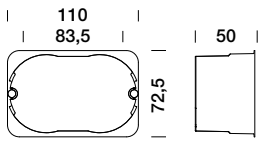
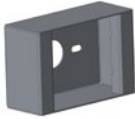
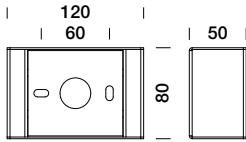
RELATED PRODUCT	NAME	NOTES	CONNECTOR	IMAGE	TECHNICAL DRAWING
MICRO STEEL	89 28 045	AISI 316L for pools	/		
NETTUNO BRONZE	89 28 065	AISI 316L for pools	/		
PICO full inox walk over	89 45 040	Recessed box equipped with connector for Ø 13 mm corrugated pipe	/		
NANO full inox walk over NANO full inox roll over	89 45 033		/		
	89 45 038		89 17 006		
	89 45 039		89 17 006		
MICRO full inox drive over MICRO full inox roll over	89 45 035		/		

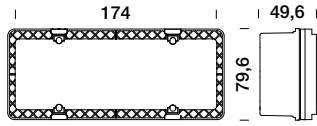

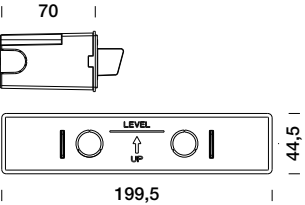

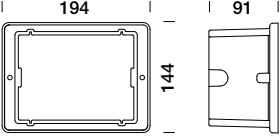

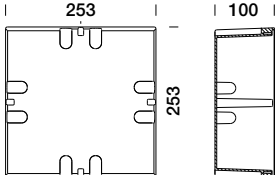
RELATED PRODUCT	NAME	NOTES	CONNECTOR	IMAGE	TECHNICAL DRAWING
MICRO full inox drive over MICRO full inox roll over	89 45 036		89 17 006 IP68 89 17 014 IP68		
	89 45 037		89 17 004 IP68 89 17 013 IP68 89 17 014 IP68		
MINI full inox drive over MINI drive over MINI roll over	89 45 015		89 17 004 IP68 89 17 014 IP68 89 17 013 IP68		
	89 45 020		89 17 004 IP68 89 17 014 IP68		
MEDIO full inox drive over	89 45 029	/			
MEDIO drive over MEDIO roll over	89 45 030		89 17 004 IP68 89 17 014 IP68		
ATLANTIQUE drive over	89 36 000	/			

Recessed boxes

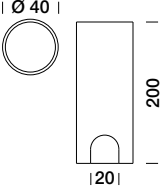
RELATED PRODUCT	NAME	NOTES	CONNECTOR	IMAGE	TECHNICAL DRAWING
GRANDE drive over	89 45 010		89 17 004		
TETRA INCASSO	89 45 060		89 17 004		
	89 45 065		89 17 004		
TETRA CONTINUO	89 45 080		/		
MINI CORNICHE walk over	89 45 089 89 45 090 89 45 092 89 45 094 89 45 093	L 162 L 362 L 662 L 962 L 1262	/		
SPY small	89 45 047 (concrete)	supplied with the products	/		
	89 45 046 (drywalls)	Fixing hole: Ø 68	/		

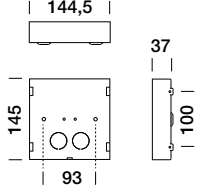
RELATED PRODUCT	NAME	NOTES	CONNECTOR	IMAGE	TECHNICAL DRAWING
SPY medium	89 45 044 (concrete) supplied with the products		/		
	89 45 045 (drywalls)	Fixing hole: L 110 H 66	/		
	89 45 052		/		
SPY large	89 45 049 (concrete) supplied with the products		/		
MASK FRAME	99 20 050		/		
PROMENADE 40	99 50 000		/		
PROMENADE 200	99 40 030		/		

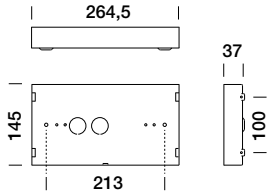
Recessed boxes

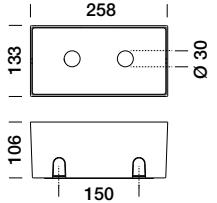
RELATED PRODUCT	NAME	NOTES	CONNECTOR	IMAGE	TECHNICAL DRAWING
NANO full inox	89 45 034				
TEAM small	89 45 122 Recessed box for drywalls/concrete				
TEAM medium	89 45 123 Recessed box for drywalls/concrete				
MILANO 2 FLIC	99 40 020 Recessed box				

RELATED PRODUCT	NAME	NOTES	CONNECTOR	IMAGE	TECHNICAL DRAWING
E2 plus	94 20 900 Recessed box drywalls				<p>105 110 150 100</p>
E4 plus	94 20 920 Recessed box drywalls				<p>162 128 200</p>
E2	89 45 115 Recessed box drywalls				<p>76,5 85 130 110 180 12 76,5 2 130 110</p>







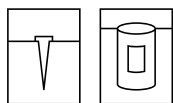



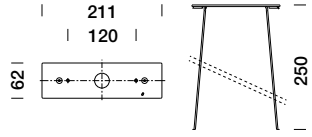

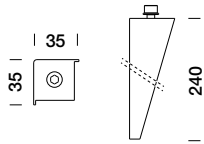
Recessed boxes

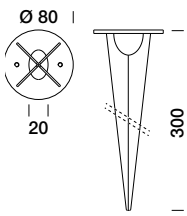
RELATED PRODUCT	NAME	NOTES	CONNECTOR	IMAGE	TECHNICAL DRAWING
E2 plaster	89 45 105 Recessed box plaster				<p>220 110 97 134</p>
E2 plaster	89 45 110 Recessed box reinforced concrete				<p>220 110 120 134</p>

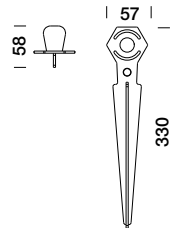
Fixing

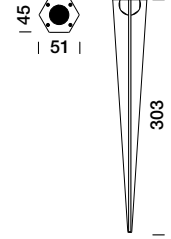

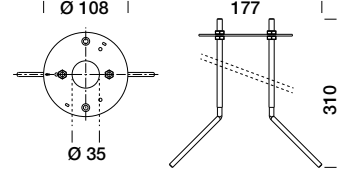





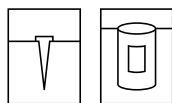



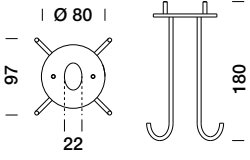

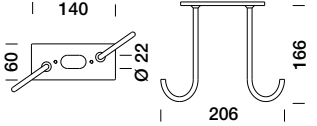
RELATED PRODUCT	NAME	CODE	IMAGE	TECHNICAL DRAWING
MESH table MESH bollard MESH floor	Spike	90 05 160 for MESH table and MESH floor (please add the accessory 90 05 165 as adaptor)		
MESH table MESH floor	Floor fixing plate	90 05 165 (IP68 connector code 89 17 014 included)		
NANO XL floodlight NANO XXL floodlight MINI ONE floodlight MINI SPECIAL floodlight MICRO SPRING floodlight	Spike	90 05 605		
NANO full inox floodlight NANO floodlight NANO XL floodlight	Spike	90 05 100		
NANO FULL INOX floodlight	Spike	90 05 101		
PASSO	Spike	90 05 120		
TARGET small floodlight TARGET medium floodlight	Spike	90 05 150		

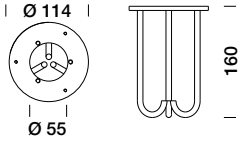
RELATED PRODUCT	NAME	CODE	IMAGE	TECHNICAL DRAWING
TARGET large floodlight	Spike	90 05 152		
MINI floodlight ONE floodlight MINI SPRING floodlight SPRING floodlight	Spike	90 05 600		
FLAMINGO bollard / floor	Spike	89 50 041		
ESAGONO	Adjustable ground fixing spikes for horizontal mounting	89 47 070		
	Stainless steel spike for vertical mounting	89 47 067		
MESH table MESH bollard MESH floor	Tie-rod	89 50 120 for MESH table and MESH floor (please add the accessory 90 05 165 as adaptor)		
NANO full inox floodlight NANO floodlight NANO XL floodlight NANO XXL floodlight	Anchor belt L 1000	90 05 105		

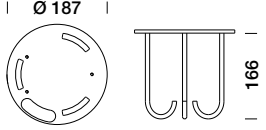
Fixing

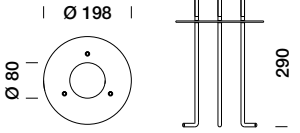

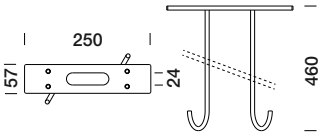
RELATED PRODUCT	NAME	CODE	IMAGE	TECHNICAL DRAWING
ALIEN bollard TUBE 3000 / 4000 T4 TETRA PARCO BLEND bollard	Tie-rod	89 50 090		
TUBE 260 mm	Tie-rod	89 50 035		
TRIS TUBE 1000 mm	Tie-rod	89 50 075		
TRIS TUBE 1000 mm	Recessed housing	89 50 080		
TRIS	Shield for two openings H 60	89 01 045		
MINI ONE bollard	Tie-rod	89 50 045		
MINI ONE bollard	Spike	90 05 190		

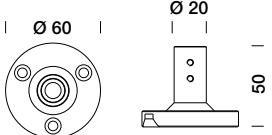
RELATED PRODUCT	NAME	CODE	IMAGE	TECHNICAL DRAWING
FLAMINGO bollard / floor	Tie-rod	89 50 040		
SLIM bollard	Tie-rod	89 50 025		
MICRO MENHIR bollard	Tie-rod	89 50 030		
MENHIR bollard	Tie-rod	89 50 003		
MENHIR bollard	Tie-rod	89 50 001		
MOON bollard	Tie-rod	89 50 070		
CHIODO bollard	Ground fixing base plate	89 51 100.01		

Fixing

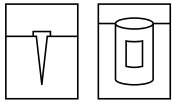







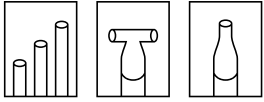

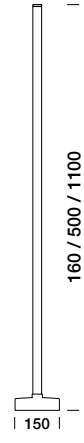
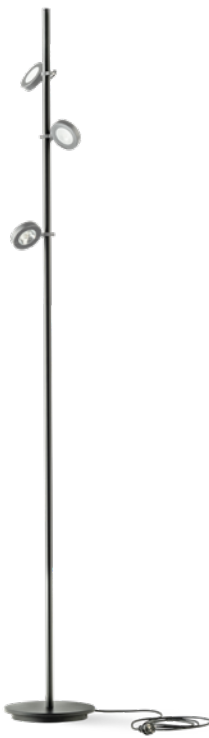
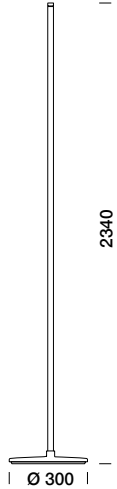

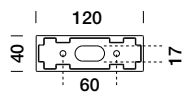
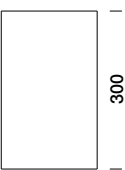

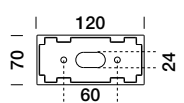
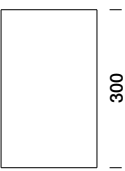

RELATED PRODUCT	NAME	CODE	IMAGE	TECHNICAL DRAWING
CHIODO bollard	Ground fixing base in AISI 316L stainless steel	89 51 102		
FROG floodlight	Spike	90 05 610		
FROG	Spike for pole	90 05 170		
FROG	Spike (in colour .01 .02 .09)	90 05 175 H. 250 mm 90 05 180 H. 600 mm 90 05 185 H. 1200 mm 90 05 186 H. 2600 mm	F.T. 160 mm F.T. 500 mm F.T. 1100 mm F.T. 2200 mm	

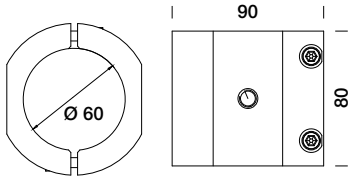
RELATED PRODUCT	NAME	CODE	IMAGE	TECHNICAL DRAWING
TEAM bollard	Tie-rod	89 50 130		
BLEND bollard	Tie-rod	89 50 125		
MINI CORNICHE applique	Stainless steel brackets for wall mounting length 60 mm	89 47 005		
MINI CORNICHE applique	Stainless steel brackets for wall mounting length 100 mm	89 47 010		
TETRA CORNICHE 360 / 900 wall effect	Stainless steel brackets for wall mounting ($\pm 15^\circ$ adjustable)	89 47 055		

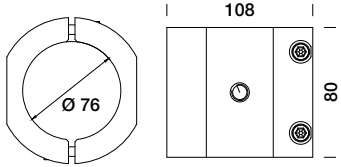
Rods / Pole extensions

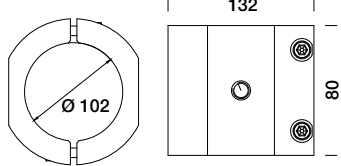

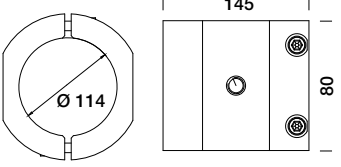
RELATED PRODUCT	NAME	CODE	IMAGE	TECHNICAL DRAWING
FROG	Base with pole (in colour .01 .02 .09)	89 51 105 H. 160 mm 89 51 110 H. 500 mm 89 51 115 H. 1100 mm		
FROG	Floor H. 2340 mm (in colour .01 .02 .09)	89 51 230		
TARGET small	Extension base	89 50 100		 
TARGET medium	Extension base	89 50 110		 

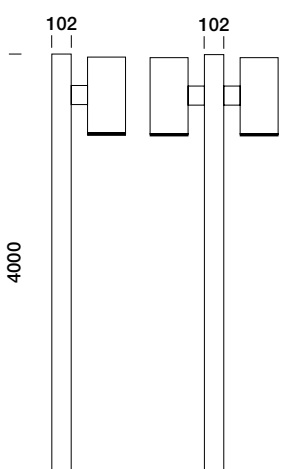
RELATED PRODUCT	NAME	CODE	IMAGE	TECHNICAL DRAWING
MINI floodlight MINI SPRING floodlight SPRING floodlight	Pole support Ø 60 mm (up to 2 Luminaires)	89 51 040		
	Pole support Ø 76 mm (up to 2 Luminaires)	89 51 076		
	Pole support Ø 102 mm (up to 2 Luminaires)	89 51 045		
	Pole support Ø 114 mm (up to 2 Luminaires)	89 51 050		
MONACO	Pole with base plate suitable for 1 luminaire	86 23 061		
	Pole with base plate suitable for 2 luminaires	86 23 062		

Rods / Pole extensions

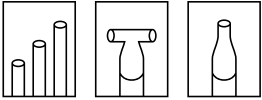

RELATED PRODUCT	NAME	CODE	IMAGE	TECHNICAL DRAWING
NANO XL floodlight NANO XXL floodlight	Aluminium rod with carbon finish and steel spike	90 05 250 H.F.T. 300 mm 90 05 252 H.F.T. 600 mm 90 05 255 H.F.T. 1100 mm 90 05 260 H.F.T. 1700 mm		
TARSIUS pole mounted	Pole 4 m Pole 6 m Pole 8 m	86 50 004 86 50 006 86 50 008		
TARSIUS pole mounted	Pole top adaptor Ø 60 / Ø 76 mm	86 50 025		
TARSIUS pole mounted	Two luminaires pole top	86 50 020		
SUN pole mounted	Pole adaptor Ø 60 / Ø 76 / Ø 102 mm	89 51 035		

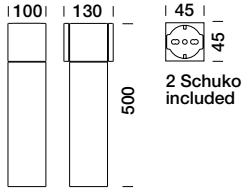
RELATED PRODUCT	NAME	CODE	IMAGE	TECHNICAL DRAWING
SERVICE POST	H 500 mm	89 10 502 (in colour .08)		 <p>100 130 45 45 500 2 Schuko included</p>

Various

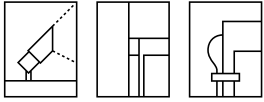



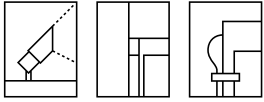

RELATED PRODUCT	NAME	CODE	IMAGE	TECHNICAL DRAWING
ESAGONO	Hook fastener	89 47 066		
ESAGONO	Adjustable wall fixing 65 mm	89 47 071		
ESAGONO	Adjustable wall fixing 100 mm	89 47 069		
ESAGONO	Adjustable wall fixing 150 mm	89 47 068		
ETEREA battery	PMMA support feet with anti-scratch rubber	94 99 007		
TEAM small TEAM medium	Rubber for side entry cable (2 PCS)	89 47 020		

Various



RELATED PRODUCT	CODE	IMAGE	RELATED PRODUCT	CODE	IMAGE
MICRO SPRING	89 05 010.01 Visor		NANO floodlight	89 35 210 Visor	
MICRO SPRING	89 05 080.01 Tube		NANO floodlight	89 35 211 Tube	
MINI SPRING	89 05 015.01 Visor		NANO XL floodlight	89 35 220 Visor	
	89 05 085.01 Tube		NANO XL floodlight	89 35 221 Tube	
SPRING	89 05 020.01 Visor		NANO XXL floodlight	89 35 230 Visor	
	89 05 090.01 Tube		NANO XXL floodlight	89 35 231 Tube	
MINI floodlight	89 05 025 Visor (in colour .01)		MINI floodlight	89 05 026 Tube shield (in colour .01)	

RELATED PRODUCT	CODE	IMAGE	RELATED PRODUCT	CODE	IMAGE
TARGET small	89 05 070 Visor		CIRCUS	89 54 001.01 Decorative ring black	
TARGET small	89 05 110 Deflector		CIRCUS	89 54 001.06 Decorative ring grey	
TARGET medium	89 05 071 Visor		CIRCUS	89 54 001.70 Decorative ring red	
TARGET medium	89 05 111 Deflector		CIRCUS	89 54 001.04 Decorative ring steel finish	
TARGET large	89 05 072 Visor		CIRCUS	89 54 001.02 Decorative ring white	
TARGET large	89 05 112 Deflector		ATLANTIQUE	89 20 000 Stainless steel ring	

Index

code / pag

e

Index code / page

CODE	PAGE	CODE	PAGE	CODE	PAGE	CODE	PAGE
10 09 611	74	15 15 267	74	32 50 116	12	40 32 662	88
10 09 612	74	15 15 513	70	32 50 166	12	40 52 611	88
10 09 614	74	15 15 563	70	32 50 216	14	40 52 612	88
10 09 615	74	15 16 216	74	32 50 266	14	40 52 661	88
10 09 616	74	15 16 217	74	32 50 316	14	40 52 662	88
10 09 617	74	15 16 266	74	32 50 366	14	40 82 611	88
10 09 618	74	15 16 267	74	32 50 816	14	40 82 612	88
10 09 661	74	15 16 513	70	32 50 866	14	40 82 661	88
10 09 662	74	15 16 563	70	32 55 116	12	40 82 662	88
10 09 664	74	15 17 311	54	32 55 166	12	42 70 119	86
10 09 665	74	15 17 313	54	32 70 116	13	42 70 169	86
10 09 666	74	15 17 317	54	32 70 166	13	45 20 318	72
10 09 667	74	15 17 318	54	32 70 216	13	45 20 368	72
10 09 668	74	15 17 361	54	32 70 266	13	45 20 518	72
10 10 111	74	15 17 363	54	32 70 616	13	45 20 568	72
10 10 113	74	15 17 367	54	32 70 666	13	50 00 611	87
10 10 161	74	15 17 368	54	32 70 816	13	50 00 612	87
10 10 163	74	15 18 613	54	32 70 866	13	50 00 661	87
10 10 615	70	15 18 663	54	33 33 611	89	50 00 662	87
10 10 665	70	15 35 610	71	33 33 612	89	50 02 116	42
10 11 611	74	15 35 611	75	33 33 613	89	50 02 119	42
10 11 612	74	15 35 612	75	33 33 614	89	50 02 166	42
10 11 614	74	15 35 660	71	33 33 661	89	50 02 169	42
10 11 615	70	15 35 661	75	33 33 662	89	50 02 196	42
10 11 661	74	15 35 662	75	33 33 663	89	50 02 199	42
10 11 662	74	15 36 610	71	33 33 664	89	50 02 216	42
10 11 664	74	15 36 611	75	33 65 610	89	50 02 219	42
10 11 665	70	15 36 612	75	33 65 611	89	50 02 266	42
10 12 111	54	15 36 660	71	33 65 613	89	50 02 269	42
10 12 113	54	15 36 661	75	33 65 614	89	50 02 296	42
10 12 118	54	15 36 662	75	33 65 660	89	50 02 299	42
10 12 161	54	16 10 117	73	33 65 661	89	50 02 616	42
10 12 163	54	16 10 167	73	33 65 663	89	50 02 619	42
10 12 168	54	16 10 217	73	33 65 664	89	50 02 666	42
10 13 615	54	16 10 267	73	33 66 600	89	50 02 669	42
10 13 665	54	16 10 616	73	33 66 601	89	50 02 696	42
10 15 611	87	16 10 666	73	33 66 603	89	50 02 699	42
10 15 612	87	16 40 519	85	33 66 604	89	50 02 816	42
10 15 614	87	16 40 569	85	33 66 610	89	50 02 819	42
10 15 661	87	16 40 619	85	33 66 611	89	50 02 866	42
10 15 662	87	16 40 669	85	33 66 613	89	50 02 869	42
10 15 664	87	19 66 611	76	33 66 614	89	50 02 896	42
10 20 610	71	19 66 616	76	33 66 660	89	50 02 899	42
10 20 611	75	19 66 621	76	33 66 661	89	50 02 916	42
10 20 612	75	19 66 626	76	33 66 663	89	50 02 919	42
10 20 660	71	19 67 611	76 / 86	33 66 664	89	50 02 966	42
10 20 661	75	19 67 616	76 / 86	34 40 419	85	50 02 969	42
10 20 662	75	19 67 621	76 / 86	34 40 469	85	50 02 996	42
10 20 911	75	19 67 626	76 / 86	34 40 519	85	50 02 999	42
10 20 961	75	19 68 611	86	34 40 569	85	50 03 116	42
10 21 610	71	19 68 616	86	34 40 619	85	50 03 119	42
10 21 611	75	19 68 621	86	34 40 669	85	50 03 166	42
10 21 612	75	19 68 626	86	34 40 719	85	50 03 169	42
10 21 660	71	19 69 611	86	34 40 769	85	50 03 196	42
10 21 661	75	19 69 616	86	34 50 601	45	50 03 199	42
10 21 662	75	19 69 621	86	34 50 606	45	50 03 216	42
10 22 610	55	19 69 626	86	34 55 911	45	50 03 219	42
10 22 660	55	30 10 116	18	34 55 916	45	50 03 266	42
10 22 819	55	30 10 166	18	34 74 119	46	50 03 269	42
10 22 869	55	30 10 216	18	34 74 169	46	50 03 296	42
10 50 611	87	30 10 266	18	34 75 119	46	50 03 299	42
10 50 612	87	30 10 316	18	34 75 169	46	50 03 616	42
10 50 614	87	30 10 366	18	34 76 116	47	50 03 619	42
10 50 661	87	30 40 116	19	34 76 166	47	50 03 666	42
10 50 662	87	30 40 166	19	34 80 119	44	50 03 669	42
10 50 664	87	30 40 216	19	34 80 169	44	50 03 696	42
10 80 611	87	30 40 266	19	34 80 219	44	50 03 699	42
10 80 612	87	30 40 316	19	34 80 269	44	50 03 816	42
10 80 614	87	30 40 366	19	40 11 111	88	50 03 819	42
10 80 661	87	30 50 216	19	40 11 112	88	50 03 866	42
10 80 662	87	30 50 266	19	40 11 161	88	50 03 869	42
10 80 664	87	30 50 316	19	40 11 162	88	50 03 896	42
15 15 211	74	30 50 366	19	40 11 211	88	50 03 899	42
15 15 212	74	30 70 116	18	40 11 212	88	50 03 916	42
15 15 214	74	30 70 166	18	40 11 261	88	50 03 919	42
15 15 215	74	30 70 216	18	40 11 262	88	50 03 966	42
15 15 216	74	30 70 266	18	40 11 311	88	50 03 969	42
15 15 217	74	32 10 116	13	40 11 312	88	50 03 996	42
15 15 261	74	32 10 166	13	40 11 361	88	50 03 999	42
15 15 262	74	32 40 216	14	40 11 362	88	50 04 116	43
15 15 264	74	32 40 266	14	40 32 611	88	50 04 119	43
15 15 265	74	32 40 316	14	40 32 612	88	50 04 166	43
15 15 266	74	32 40 366	14	40 32 661	88	50 04 169	43

CODE	PAGE	CODE	PAGE	CODE	PAGE	CODE	PAGE
50 04 196	43	60 93 669	21	83 73 407	60	83 98 101	26
50 04 199	43	60 93 819	21	83 73 408	60	83 98 103	26
50 04 216	43	60 93 869	21	83 74 401	63	83 98 107	26
50 04 219	43	60 93 919	21	83 74 403	63	83 98 108	26
50 04 266	43	60 93 969	21	83 74 408	63	83 98 301	26
50 04 269	43	60 94 619	21	83 75 101	62	83 98 303	26
50 04 296	43	60 94 669	21	83 75 103	62	83 98 307	26
50 04 299	43	61 04 118	72	83 75 108	62	83 98 308	26
50 04 616	43	61 04 168	72	83 76 101	62	83 98 501	27
50 04 619	43	72 04 118	72	83 76 103	62	83 98 503	27
50 04 666	43	72 04 168	72	83 76 108	62	83 98 507	27
50 04 669	43	73 04 118	72	83 77 101	59	83 98 508	27
50 04 696	43	73 04 168	72	83 77 103	59	83 98 601	28
50 04 699	43	80 30 511	34	83 77 107	59	83 98 603	28
50 04 816	43	80 30 513	34	83 77 108	59	83 98 607	28
50 04 819	43	80 30 561	34	83 77 201	59	83 98 608	28
50 04 866	43	80 30 563	34	83 77 203	59	83 98 701	27
50 04 869	43	80 30 711	34	83 77 207	59	83 98 703	27
50 04 896	43	80 30 713	34	83 77 208	59	83 98 707	27
50 04 899	43	80 30 761	34	83 78 501	61	83 98 708	27
50 04 916	43	80 30 763	34	83 78 508	61	84 00 011	24
50 04 919	43	80 61 511	36	83 79 101	30	84 00 013	24
50 04 966	43	80 61 513	36	83 79 103	30	84 00 015	24
50 04 969	43	80 61 561	36	83 79 108	30	84 00 017	24
50 04 996	43	80 61 563	36	83 80 201	31	84 00 018	24
50 04 999	43	80 61 711	36	83 80 203	31	84 00 061	24
50 10 611	87	80 61 713	36	83 80 208	31	84 00 063	24
50 10 612	87	80 61 761	36	83 81 401	34	84 00 065	24
50 10 661	87	80 61 763	36	83 81 403	34	84 00 067	24
50 10 662	87	83 01 101	30	83 81 407	34	84 00 068	24
50 26 316	68	83 01 103	30	83 81 408	34	84 01 019	30
50 26 366	68	83 01 108	30	83 88 401	68	84 01 069	30
50 26 416	68	83 02 201	32	83 88 403	68	84 01 911	30
50 26 466	68	83 02 203	32	83 88 407	68	84 01 913	30
50 34 611	90	83 02 208	32	83 88 408	68	84 01 918	30
50 34 612	90	83 03 201	33	83 91 101	80	84 01 961	30
50 34 613	90	83 03 203	33	83 91 103	80	84 01 963	30
50 34 614	90	83 03 208	33	83 91 107	80	84 01 968	30
50 34 661	90	83 05 401	34	83 91 108	80	84 02 411	32
50 34 662	90	83 05 403	34	83 91 301	80	84 02 413	32
50 34 663	90	83 05 408	34	83 91 303	80	84 02 418	32
50 34 664	90	83 06 401	36	83 91 307	80	84 02 461	32
50 35 611	90	83 06 403	36	83 91 308	80	84 02 463	32
50 35 612	90	83 06 408	36	83 91 501	81	84 02 468	32
50 35 613	90	83 08 501	37	83 91 503	81	84 02 611	32
50 35 614	90	83 08 503	37	83 91 507	81	84 02 613	32
50 35 661	90	83 08 507	37	83 91 508	81	84 02 618	32
50 35 662	90	83 08 508	37	83 91 601	82	84 02 619	32
50 35 663	90	83 12 101	54	83 91 603	82	84 02 661	32
50 35 664	90	83 12 103	54	83 91 607	82	84 02 663	32
50 40 316	68	83 12 108	54	83 91 608	82	84 02 668	32
50 40 366	68	83 21 201	58	83 91 701	81	84 02 669	32
50 40 416	68	83 21 203	58	83 91 703	81	84 03 411	33
50 40 466	68	83 21 208	58	83 91 707	81	84 03 413	33
50 80 019	29	83 22 501	57	83 91 708	81	84 03 418	33
50 80 069	29	83 22 503	57	83 92 101	63	84 03 461	33
50 80 319	38	83 22 508	57	83 92 103	63	84 03 463	33
50 80 369	38	83 23 401	56	83 92 107	63	84 03 468	33
53 80 111	78	83 23 403	56	83 92 108	63	84 03 611	33
53 80 118	78	83 23 408	56	83 92 301	64	84 03 613	33
53 80 161	78	83 24 101	56	83 92 303	64	84 03 618	33
53 80 168	78	83 24 103	56	83 92 307	64	84 03 619	33
53 80 211	78	83 24 108	56	83 92 308	64	84 03 661	33
53 80 215	78	83 27 103	69	83 92 501	64	84 03 663	33
53 80 218	78	83 27 108	69	83 92 503	64	84 03 668	33
53 80 261	78	83 29 201	67	83 92 507	64	84 03 669	33
53 80 265	78	83 29 203	67	83 92 508	64	84 05 311	34
53 80 268	78	83 29 208	67	83 92 601	65	84 05 313	34
55 33 613	79	83 30 101	66	83 92 603	65	84 05 318	34
55 33 663	79	83 30 103	66	83 92 607	65	84 05 319	34
60 90 619	21	83 30 108	66	83 92 608	65	84 05 361	34
60 90 669	21	83 33 501	37	83 92 701	65	84 05 363	34
60 90 819	21	83 33 503	37	83 92 703	65	84 05 368	34
60 90 869	21	83 33 507	37	83 92 707	65	84 05 369	34
60 90 919	21	83 33 508	37	83 92 708	65	84 06 311	36
60 90 969	21	83 49 401	54	83 96 201	28	84 06 313	36
60 91 619	21	83 49 403	54	83 96 203	28	84 06 318	36
60 91 669	21	83 49 407	54	83 96 207	28	84 06 319	36
60 91 819	21	83 49 408	54	83 96 208	28	84 06 361	36
60 91 869	21	83 72 401	60	83 96 501	38	84 06 363	36
60 91 919	21	83 72 407	60	83 96 503	38	84 06 368	36
60 91 969	21	83 72 408	60	83 96 507	38	84 06 369	36
60 93 619	21	83 73 401	60	83 96 508	38	84 08 511	37

CODE	PAGE	CODE	PAGE	CODE	PAGE	CODE	PAGE
84 08 513	37	84 13 468	29	84 22 563	57	84 38 111	76
84 08 517	37	84 14 511	84	84 22 568	57	84 38 118	76
84 08 518	37	84 14 517	84	84 23 311	56	84 38 161	76
84 08 561	37	84 14 518	84	84 23 313	56	84 38 168	76
84 08 563	37	84 14 561	84	84 23 318	56	84 39 111	76
84 08 567	37	84 14 567	84	84 23 361	56	84 39 115	76
84 08 568	37	84 14 568	84	84 23 363	56	84 39 118	76
84 09 016	41	84 14 611	84	84 23 368	56	84 39 161	76
84 09 066	41	84 14 617	84	84 24 111	56	84 39 165	76
84 09 716	41	84 14 618	84	84 24 113	56	84 39 168	76
84 09 766	41	84 14 661	84	84 24 118	56	84 42 411	78
84 09 816	41	84 14 667	84	84 24 161	56	84 42 418	78
84 09 866	41	84 14 668	84	84 24 163	56	84 42 461	78
84 10 116	41	84 15 211	84	84 24 168	56	84 42 468	78
84 10 166	41	84 15 217	84	84 25 311	58	84 43 411	78
84 10 216	41	84 15 218	84	84 25 313	58	84 43 415	78
84 10 266	41	84 15 261	84	84 25 318	58	84 43 418	78
84 11 111	80	84 15 267	84	84 25 361	58	84 43 461	78
84 11 113	80	84 15 268	84	84 25 363	58	84 43 465	78
84 11 116	80	84 15 411	84	84 25 368	58	84 43 468	78
84 11 117	80	84 15 417	84	84 26 413	69	84 46 719	79
84 11 118	80	84 15 418	84	84 26 418	69	84 46 769	79
84 11 161	80	84 15 461	84	84 26 463	69	84 47 119	46
84 11 163	80	84 15 467	84	84 26 468	69	84 47 169	46
84 11 166	80	84 15 468	84	84 27 113	69	84 48 919	46
84 11 167	80	84 16 511	83	84 27 118	69	84 48 969	46
84 11 168	80	84 16 513	83	84 27 163	69	84 70 011	25
84 11 311	80	84 16 517	83	84 27 168	69	84 70 013	25
84 11 313	80	84 16 518	83	84 29 611	67	84 70 015	25
84 11 316	80	84 16 561	83	84 29 613	67	84 70 017	25
84 11 317	80	84 16 563	83	84 29 618	67	84 70 018	25
84 11 318	80	84 16 567	83	84 29 661	67	84 70 061	25
84 11 361	80	84 16 568	83	84 29 663	67	84 70 063	25
84 11 363	80	84 16 611	83	84 29 668	67	84 70 065	25
84 11 366	80	84 16 613	83	84 30 019	66	84 70 067	25
84 11 367	80	84 16 617	83	84 30 069	66	84 70 068	25
84 11 368	80	84 16 618	83	84 30 911	66	84 72 311	60
84 11 511	80	84 16 661	83	84 30 913	66	84 72 317	60
84 11 513	80	84 16 663	83	84 30 918	66	84 72 318	60
84 11 516	80	84 16 667	83	84 30 961	66	84 72 361	60
84 11 517	80	84 16 668	83	84 30 963	66	84 72 367	60
84 11 518	80	84 17 411	82	84 30 968	66	84 72 368	60
84 11 561	80	84 17 413	82	84 31 011	66	84 73 311	60
84 11 563	80	84 17 417	82	84 31 013	66	84 73 317	60
84 11 566	80	84 17 418	82	84 31 018	66	84 73 318	60
84 11 567	80	84 17 461	82	84 31 061	66	84 73 361	60
84 11 568	80	84 17 463	82	84 31 063	66	84 73 367	60
84 11 611	82	84 17 467	82	84 31 068	66	84 73 368	60
84 11 613	82	84 17 468	82	84 32 011	52	84 74 311	63
84 11 616	82	84 18 511	29	84 32 013	52	84 74 318	63
84 11 617	82	84 18 513	29	84 32 017	52	84 74 361	63
84 11 618	82	84 18 517	29	84 32 018	52	84 74 368	63
84 11 661	82	84 18 518	29	84 32 061	52	84 75 111	62
84 11 663	82	84 18 561	29	84 32 063	52	84 75 113	62
84 11 666	82	84 18 563	29	84 32 067	52	84 75 118	62
84 11 667	82	84 18 567	29	84 32 068	52	84 75 161	62
84 11 668	82	84 18 568	29	84 33 511	37	84 75 163	62
84 11 711	80	84 19 111	59	84 33 513	37	84 75 168	62
84 11 713	80	84 19 113	59	84 33 517	37	84 76 111	62
84 11 716	80	84 19 117	59	84 33 518	37	84 76 113	62
84 11 717	80	84 19 118	59	84 33 561	37	84 76 118	62
84 11 718	80	84 19 161	59	84 33 563	37	84 76 161	62
84 11 761	80	84 19 163	59	84 33 567	37	84 76 163	62
84 11 763	80	84 19 167	59	84 33 568	37	84 76 168	62
84 11 766	80	84 19 168	59	84 34 011	40	84 78 511	61
84 11 767	80	84 19 211	59	84 34 012	40	84 78 518	61
84 11 768	80	84 19 213	59	84 34 061	40	84 78 561	61
84 12 611	38	84 19 217	59	84 34 062	40	84 78 568	61
84 12 613	38	84 19 218	59	84 36 311	77	84 79 011	40
84 12 617	38	84 19 261	59	84 36 317	77	84 79 012	40
84 12 618	38	84 19 263	59	84 36 318	77	84 79 061	40
84 12 661	38	84 19 267	59	84 36 361	77	84 79 062	40
84 12 663	38	84 19 268	59	84 36 367	77	84 79 111	30
84 12 667	38	84 21 611	58	84 36 368	77	84 79 113	30
84 12 668	38	84 21 613	58	84 37 311	77	84 79 118	30
84 13 411	29	84 21 618	58	84 37 315	77	84 79 161	30
84 13 413	29	84 21 661	58	84 37 317	77	84 79 163	30
84 13 417	29	84 21 663	58	84 37 318	77	84 79 168	30
84 13 418	29	84 21 668	58	84 37 361	77	84 79 911	30
84 13 461	29	84 22 511	57	84 37 365	77	84 79 913	30
84 13 463	29	84 22 513	57	84 37 367	77	84 79 918	30
84 13 467	29	84 22 518	57	84 37 368	77	84 79 961	30
		84 22 561	57			84 79 963	30

CODE	PAGE	CODE	PAGE	CODE	PAGE	CODE	PAGE
84 79 968	30	84 92 666	65	84 98 669	28	88 20 608	51
84 80 211	31	84 92 667	65	84 98 711	29	88 20 611	51
84 80 213	31	84 92 668	65	84 98 713	29	88 20 613	51
84 80 218	31	84 92 669	65	84 98 716	29	88 20 617	51
84 80 261	31	84 92 711	65	84 98 717	29	88 20 618	51
84 80 263	31	84 92 713	65	84 98 718	29	88 20 661	51
84 80 268	31	84 92 716	65	84 98 719	29	88 20 663	51
84 80 611	31	84 92 717	65	84 98 761	29	88 20 667	51
84 80 613	31	84 92 718	65	84 98 763	29	88 20 668	51
84 80 618	31	84 92 719	65	84 98 766	29	88 40 101	48
84 80 619	31	84 92 761	65	84 98 767	29	88 40 103	48
84 80 661	31	84 92 763	65	84 98 768	29	88 40 108	48
84 80 663	31	84 92 766	65	84 98 769	29	88 40 111	48
84 80 668	31	84 92 767	65	86 23 061	127	88 40 113	48
84 80 669	31	84 92 768	65	86 23 062	127	88 40 118	48
84 81 311	34	84 92 769	65	86 50 004	128	88 40 161	48
84 81 313	34	84 95 011	24	86 50 006	128	88 40 163	48
84 81 317	34	84 95 015	24	86 50 008	128	88 40 168	48
84 81 318	34	84 95 061	24	86 50 020	128	88 40 301	48
84 81 361	34	84 95 065	24	86 50 025	128	88 40 303	48
84 81 363	34	84 96 211	28	87 12 616	92	88 40 308	48
84 81 367	34	84 96 213	28	87 12 666	92	88 40 311	48
84 81 368	34	84 96 217	28	87 12 719	92	88 40 313	48
84 86 614	19	84 96 218	28	87 12 769	92	88 40 318	48
84 86 616	19	84 96 261	28	87 50 718	91	88 40 361	48
84 86 664	19	84 96 263	28	87 50 719	91	88 40 363	48
84 86 666	19	84 96 267	28	87 50 768	91	88 40 368	48
84 88 411	67	84 96 268	28	87 50 769	91	88 40 418	48
84 88 413	67	84 96 511	38	87 50 918	91	88 40 419	48
84 88 417	67	84 96 513	38	87 50 919	91	88 40 468	48
84 88 418	67	84 96 517	38	87 50 968	91	88 40 469	48
84 88 461	67	84 96 518	38	87 50 969	91	88 40 601	49
84 88 463	67	84 96 561	38	87 55 719	91	88 40 603	49
84 88 467	67	84 96 563	38	87 55 769	91	88 40 608	49
84 88 468	67	84 96 567	38	88 00 011	15	88 40 611	49
84 88 518	67	84 96 568	38	88 00 013	15	88 40 613	49
84 88 568	67	84 98 111	26	88 00 018	15	88 40 618	49
84 88 718	67	84 98 113	26	88 00 061	15	88 40 661	49
84 88 768	67	84 98 116	26	88 00 063	15	88 40 663	49
84 92 111	63	84 98 117	26	88 00 068	15	88 40 668	49
84 92 113	63	84 98 118	26	88 00 111	15	88 40 718	49
84 92 116	63	84 98 119	26	88 00 113	15	88 40 719	49
84 92 117	63	84 98 161	26	88 00 118	15	88 40 768	49
84 92 118	63	84 98 163	26	88 00 161	15	88 40 769	49
84 92 119	63	84 98 166	26	88 00 163	15	88 50 718	47
84 92 161	63	84 98 167	26	88 00 168	15	88 50 719	47
84 92 163	63	84 98 168	26	88 14 511	56	88 50 768	47
84 92 166	63	84 98 169	26	88 14 513	56	88 50 769	47
84 92 167	63	84 98 311	26	88 14 518	56	88 50 918	47
84 92 168	63	84 98 313	26	88 14 561	56	88 50 919	47
84 92 169	63	84 98 316	26	88 14 563	56	88 50 968	47
84 92 311	64	84 98 317	26	88 14 568	56	88 50 969	47
84 92 313	64	84 98 318	26	88 15 811	57	89 01 045	122
84 92 316	64	84 98 319	26	88 15 813	57	89 05 010	132
84 92 317	64	84 98 361	26	88 15 861	57	89 05 015	132
84 92 318	64	84 98 363	26	88 15 863	57	89 05 020	132
84 92 319	64	84 98 366	26	88 20 101	50	89 05 025	132
84 92 361	64	84 98 367	26	88 20 103	50	89 05 026	132
84 92 363	64	84 98 368	26	88 20 107	50	89 05 060	110
84 92 366	64	84 98 369	26	88 20 108	50	89 05 065	110
84 92 367	64	84 98 511	27	88 20 111	50	89 05 066	110
84 92 368	64	84 98 513	27	88 20 113	50	89 05 070	133
84 92 369	64	84 98 516	27	88 20 117	50	89 05 071	133
84 92 511	64	84 98 517	27	88 20 118	50	89 05 072	133
84 92 513	64	84 98 518	27	88 20 161	50	89 05 080	132
84 92 516	64	84 98 519	27	88 20 163	50	89 05 085	132
84 92 517	64	84 98 561	27	88 20 167	50	89 05 090	132
84 92 518	64	84 98 563	27	88 20 168	50	89 05 110	133
84 92 519	64	84 98 566	27	88 20 201	50	89 05 111	133
84 92 561	64	84 98 567	27	88 20 203	50	89 05 112	133
84 92 563	64	84 98 568	27	88 20 207	50	89 10 502	129
84 92 566	64	84 98 569	27	88 20 208	50	89 17 004	109
84 92 567	64	84 98 611	28	88 20 211	50	89 17 006	109
84 92 568	64	84 98 613	28	88 20 213	50	89 17 011	105
84 92 569	64	84 98 616	28	88 20 217	50	89 17 012	109
84 92 611	65	84 98 617	28	88 20 218	50	89 17 013	109
84 92 613	65	84 98 618	28	88 20 261	50	89 17 014	109
84 92 616	65	84 98 619	28	88 20 263	50	89 17 021	109
84 92 617	65	84 98 661	28	88 20 267	50	89 18 015	110
84 92 618	65	84 98 663	28	88 20 268	50	89 18 055	110
84 92 619	65	84 98 666	28	88 20 601	51	89 18 057	110
84 92 661	65	84 98 667	28	88 20 603	51	89 18 058	110
84 92 663	65	84 98 668	28	88 20 607	51	89 18 059	110

CODE	PAGE	CODE	PAGE	CODE	PAGE
89 18 205	111	89 50 110	126	94 02 816	20
89 18 610	111	89 50 120	121	94 02 866	20
89 18 615	111	89 50 125	125	94 03 013	97
89 18 650	111	89 50 130	125	94 03 015	97
89 18 655	111	89 51 035	128	94 03 093	97
89 18 659	111	89 51 040	127	94 03 095	97
89 18 660	111	89 51 045	127	94 04 411	17
89 18 665	111	89 51 050	127	94 04 461	17
89 18 670	110	89 51 100	123	94 04 711	17
89 18 675	110	89 51 102	124	94 04 761	17
89 18 750	111	89 51 105	126	94 05 011	52
89 18 755	111	89 51 110	126	94 05 013	52
89 18 780	110	89 51 115	126	94 05 017	52
89 18 785	110	89 51 230	126	94 05 018	52
89 18 786	110	89 54 001	133	94 05 061	52
89 18 787	110	89 56 014	105	94 05 063	52
89 20 000	133	89 56 019	105	94 05 067	52
89 28 045	112	89 56 036	108	94 05 068	52
89 28 065	112	89 56 039	97	94 05 111	53
89 35 210	132	89 56 047	107	94 05 118	53
89 35 211	132	89 56 054	107	94 05 161	53
89 35 220	132	89 56 059	107	94 05 168	53
89 35 221	132	89 56 063	104	94 05 213	53
89 35 230	132	89 56 069	107	94 05 218	53
89 35 231	132	89 56 074	106	94 05 263	53
89 36 000	113	89 56 090	107	94 05 268	53
89 45 010	114	89 56 091	107	94 10 030	98
89 45 015	113	89 56 103	107	94 10 111	98
89 45 020	113	89 56 104	106	94 10 113	98
89 45 025	113	89 56 109	107	94 10 118	98
89 45 029	113	89 56 110	104	94 11 211	98
89 45 030	113	89 56 114	107	94 11 213	98
89 45 031	113	89 56 115	104	94 11 218	98
89 45 033	112	89 56 116	108	94 12 000	99
89 45 034	116	89 56 117	107	94 14 219	16
89 45 035	112	89 56 119	105	94 14 319	16
89 45 036	113	89 56 120	105	94 14 369	16
89 45 037	113	89 56 121	105	94 14 419	17
89 45 038	112	89 56 122	105	94 14 469	17
89 45 039	112	89 56 123	105	94 14 819	16
89 45 040	112	89 56 127	106	94 14 869	16
89 45 044	115	89 56 135	104	94 14 919	17
89 45 045	115	89 56 151	104	94 14 969	17
89 45 046	114	89 56 154	104	94 20 013	96
89 45 047	114	89 56 157	104	94 20 018	96
89 45 049	115	89 56 158	104	94 20 093	96
89 45 052	115	89 56 172	106	94 20 098	96
89 45 060	114	89 56 215	108	94 20 213	96
89 45 065	114	89 56 219	108	94 20 218	96
89 45 080	114	89 56 300	106	94 20 293	96
89 45 089	114	89 56 307	106	94 20 298	96
89 45 090	114	89 56 308	106	94 20 900	117
89 45 092	114	89 56 312	106	94 20 920	117
89 45 093	114	89 56 324	106	94 99 007	130
89 45 094	114	90 05 100	120	99 20 050	115
89 45 105	118	90 05 101	120	99 40 020	116
89 45 110	118	90 05 105	121	99 40 030	115
89 45 115	97	90 05 120	120	99 50 000	115
89 45 122	116	90 05 125	48	32 51 116 .120	12
89 45 123	116	90 05 130	14	32 51 116 .121	12
89 47 005	125	90 05 150	120	32 51 116 .123	12
89 47 010	125	90 05 152	121	32 51 116 .124	12
89 47 020	130	90 05 160	120	32 56 116 .120	12
89 47 055	125	90 05 165	120	32 56 116 .121	12
89 47 066	130	90 05 170	124	32 56 116 .123	12
89 47 067	121	90 05 175	124	32 56 116 .124	12
89 47 068	130	90 05 180	124	94 03 013 IP	97
89 47 069	130	90 05 185	124	94 03 015 IP	97
89 47 070	121	90 05 186	124	94 03 093 IP	97
89 47 071	130	90 05 190	122	94 03 095 IP	97
89 50 001	123	90 05 250	127		
89 50 003	123	90 05 252	127		
89 50 025	123	90 05 255	127		
89 50 030	123	90 05 260	127		
89 50 035	122	90 05 600	121		
89 50 040	123	90 05 605	120		
89 50 041	121	90 05 610	124		
89 50 045	122	94 02 116	20		
89 50 070	123	94 02 166	20		
89 50 075	122	94 02 216	20		
89 50 080	122	94 02 266	20		
89 50 090	122	94 02 316	20		
89 50 100	126	94 02 366	20		

Code reading and creation

SAMPLE CODE: 8401011.06

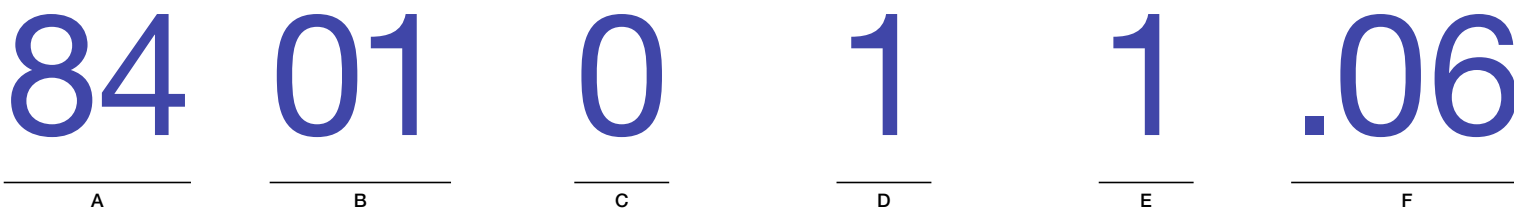

A **CATEGORY**

The following number identifies the category of the product. This datum **CANNOT** be changed by the customer at the time of code configuration.

B **PRODUCT COLLECTION**

The following number identifies the collection the product belongs to. This datum **CANNOT** be changed by the customer at the time of code configuration.

C **VARIABLE DATA**

This datum **CANNOT** be changed by the customer at the time of code configuration.

D **LED COLOUR TEMPERATURE**

This datum indicates the LED colour temperature.

IN THIS CATALOGUE WE PROPOSE A SELECTION OF LED COLOURS FOR PRODUCTS AVAILABLE IN STOCK.

The following LED colours are available, upon request, with no change in price:
 1 = 3000K; 6 = 4000K
 Available upon request, with extra cost:
 9 = 2700K; 7 = 5000K; 8 = Dynamic White; 0 = RGBW;
 4 = Amber; 2 = Red; 3 = Green; 5 = Blue

E **OPENING BEAM / OPTICS**

The figure indicates the width of the light beam / optics.

IN THIS CATALOGUE WE OFFER A RANGE OF PRODUCTS WITH SPECIFIC OPTICS IN STOCK.

The following optics are available, subject to verification, with no change in price:
 1 = Spot
 3 = Medium
 6 = Soft
 7 = Elliptical
 8 = Wide

F **PRODUCT FINISHING AND/OR COLOUR CODE**

The number after the dot (.) identifies the exterior finishing of the product.

IN THIS CATALOGUE WE OFFER A RANGE OF SPECIFIC FINISHES FOR THE PRODUCTS IN STOCK.

The following colours are available, upon request, with no change in price:
 .01 = BLACK
 .02 = WHITE
 .06 = GREY
 .07 = CORTEN
 .08 = ANTHRACITE
 .09 = BRONZE

→ For all updates please visit our website platek.eu

GENERAL SALES CONDITIONS

scope

These sales conditions regulate all current and future relations between Platek and the Buyer, save any exceptions specifically agreed in writing.

order acceptance and payment

Orders are always subject to acceptance by Platek which reserves the right to refuse them within 30 days from receipt. For the first supply, payment is in advance upon notice of goods ready; for subsequent supplies, payment to be agreed.

delivery

The delivery terms are approximate; the Buyer shall not be entitled to either fully or partially cancel the orders, nor to be refund for damages in the case of delayed or partial deliveries, for any reason whatsoever. The goods travel under the responsibility and at the risk of the Buyer, including when carriage free delivery has been agreed. In any case Platek disclaims all liability for both missing goods and for faults of any kind caused by stowage and/or loading or transport. In its own interest, the Buyer must check the quantity of goods and its packaging condition before accepting the goods and, if necessary, must report any discrepancies to the carrier.

warranty

We provide a 5-years warranty on the components by an accurate selection of LED light sources, the electronic parts with high reliability and to the use of systems of protection against voltage spikes inside our products. No registration nor specific request is required for the extended warranty. Furthermore, the warranty on other components of the products is extended to 3 years.

The warranty is only valid and effective as long as:

- the products are used for the purposes for which they were intended in accordance with the technical specifications indicated in the instruction manuals with ambient temperature of 40°C or less;
- the products have been installed by skilled technicians according to the instructions provided, remembering that class I products require ground connection;
- the products are powered by power supply units delivered by Platek and, whenever required, fitted in Platek casings;
- product installation is certified by the installer in compliance with applicable regulations; this certification must be attached to a copy of the purchasing invoice whenever a claim is made;
- the electronic components supplied by Platek and made by third parties (power supply units, control devices) correspond to the warranty conditions of Platek within the limits established by the individual manufacturers; the level of defectiveness of the LED exceeds nominal level of 0.2% / 1000 hours of operation.
- the products have been fully paid for.

All claims relating to faulty products must be sent in writing to Platek within 14 days from the date of discovery of the fault, under penalty of invalidation, with the express indication of the model, the delivery date, the description of the fault and the quantity of faulty products;

what the warranty does not cover

Platek expressly disclaims all liability in the following cases:

- incorrect or unreasonable use of the products, and/or their incorrect storage;
- damage or bad operation caused by jobs done on the products which have not been previously authorized in writing by Platek [e.g., disassembly, assembly, alterations, replacement, etc.];
- if quality and performance have been impaired by fitting accessories not approved by Platek;
- products have been modified, tampered with or repaired by third parties without the prior authorization of Platek;
- incorrect electrical and/or mechanical installation of products, e.g., without ground connection for class 1 products;
- products have been damaged after being shipped by Platek;
- limit values of environment temperature and voltage are higher than envisaged and/or product have been exposed to mechanical loads not in conformity with intended product use;
- product faults due to unforeseen and unexpected events, including electric discharges and lightning;
- electric system operates in an environment with characteristics not in conformity with those needed for correct operation, including line surges with amplitude above 1000 V between lead and lead (L and N) and 2000 V between lead and ground (L and PE, N and PE) in accordance with IEC 61000-4-5 (2005-11), i.e. appliances installed on systems without overvoltage cut-outs of any kind;

Product flow is 70% or more of nominal within the 50,000 hours. Variations in colour

temperature and light flow are within the tolerance limits set by the LED manufacturer; these can in fact vary from one lot to another. The products must be wired in compliance with our instruction sheets, supplied with the product itself. In case the product is equipped with a power supply cable, the junction to the line must be performed in order to guarantee an IP protection rating aligned or higher than the IP rating of the product itself.

warranty acceptance procedures

In case Platek acknowledges the fault, it may choose to either replace or repair the faulty products or suggest an alternative product having the same essential characteristics;

In the event of repair or replacement being impossible or exceeding the cost of the billed value of the faulty products, Platek shall be entitled to withdraw from the sales contract and refund the purchase price to the buyer (after deducting transport and installation costs);

Platek must always be able to examine the faulty product. Disassembly and transport costs to the charge of the buyer;

The warranty covers the services indicated at para. 6. Any costs relating to the disassembly of the faulty products and to installation and/ or replacement (new or repaired) shall be to the charge of the buyer, including: daily allowances and transport costs, lifting mechanisms, scaffolding, or any other accessory cost; Platek disclaims all liability for any material or immaterial damage suffered by the buyer or by third parties caused by the ascertained fault, such as the loss of usage, loss of profits and loss of energy saving; nevertheless, in case of serious damage caused by product technical faults due to manufacturing, design or material defects traceable back to Platek, the latter is willing to contribute with a refund amounting to at most 10% the value of the invoiced goods, as a contribution to the documented costs sustained by the Buyer. Such contribution shall be defined and agreed from time to time.

returned goods

No returned goods can be accepted without the prior written authorization of Platek; without such authorization, the goods will be rejected and returned to sender. Authorized returned goods must be sent carriage free, in perfect condition and in the original packaging, otherwise Platek reserves the right to charge the costs sustained for repairs to the Buyer. Authorized returned goods will be accredited at purchase price and shall be subject to a 15% conventional expense refund.

modifications to products

Platek reserves the right to make improvements or modifications to its products, at any time and according to its undisputable judgement and without the need for prior notice. The descriptions, illustrations and technical data contained in Platek catalogues, leaflets, price lists, etc. shall not be deemed binding.

retention of title

Platek shall retain title of the products until the sales prices has been fully paid.

applicable law - disputes

For everything not indicated in these conditions, the laws of Italy shall apply. In case of any disputes the only competent court of law shall be that of Brescia. Platek nevertheless reserves the right to proceed through the court of law where the Buyer is located.

Platek Srl
Registered Office: Via Paderno, 19
Head Office: Via Marrocco, 4
25050—Rodengo Saiano (BS), Italy
P.Iva 03320290178
C.F. 03007130176

T +39 030 68 18 201
F +39 030 68 16 567
info@platek.eu
www.platek.eu

Art Direction
Gusto IDS, Platek

Graphic design
Gusto IDS

Photo
Ottavio Tomasini
Germano Borrelli

Print
Color Art

Paper
Arcoprint Extra White 110 g/m²
Arcoprint Extra White 250 g/m²

Printing
April 2019

© Platek 2019

Platek online
facebook.com/platek
twitter.com/platek
instagram.com/platek
youtube.com/platek

Operating Catalogue

2019